

RICHARDSONS

Tel: 01642 242228 Web: www.richardsonsuk.co.uk

EQUIPMENT FOR INDUSTRIAL & COMMERCIAL INTERIORS



Image courtesy of Ginetta Cars

Hazardous storage

Workbenches

Storage cabinets

Stainless steel equipment



Certificate No. FM 501458
BS EN ISO 9001:2008



Quality products
made in the UK

QUALITY DOESN'T COME ANY HIGHER TOUGH DOESN'T COME ANY TOUGHER

With over a hundred years of experience, Bedford is the UK's leading manufacturer of industrial steel equipment that's built to last in even the most demanding conditions.

Our products include workbenches, work stations, trolleys, hazardous storage, cupboards, cabinets, toolboxes and stainless steel equipment. These are found in a wide range of locations - pharmaceutical, food preparation, industrial workshops, health,

education, retail, defence, motorsport and many more. Bedford services are equally extensive, covering design, manufacture, installation and on-going support.

No matter whether you're looking for a single item or a full installation, we'll work with you to find the fastest, most economical and most appropriate answer to your needs.



CONTENTS

Plant, equipment and services	4 – 5
Hazardous Storage	6
Flammable Storage Cabinets	9
Stock Flammable Storage Cabinets	10
Grey Flammable Storage Cabinets	12
Stainless Steel Flammable Storage Cabinets	13
COSHH Cabinets	14
Acid & Alkali Storage Cabinets	15
Pesticide & Agrochemical Storage Cabinets	16
First Aid Cabinets	17
PPE Cabinets	18
Heavy Duty Hazardous Cabinets	19
Workbenches	20
Premier 1 Medium Duty Workbench System	22-23
Premier 2 Heavy Duty Workbench System	24-25
Premier 3 Square Tube Workbench System	26
Premier 4 Cantilever Workbench System	26
Premier Pedestal Workbench System	27
PREM-ECON 1 Medium Duty Workbench System	28
PREM-ECON 1 Medium Duty Mobile Workbench System	29
PREM-ECON 2 Heavy Duty Workbench System	30
ESD Workbench Accessories	31
Infinite Heavy Duty Workbench System	32-33
Medium Duty Square Tube Workbenches	34
Medium Duty Cantilever Workbenches	35
Workbench Accessories	36
Medium & Heavy Duty Workbenches	37
Extra Heavy Workbenches	38
Height Adjustable Workbenches	39
Timber Workbenches	40-41
Industrial Seating	42
Premier Trolleys	43
General Purpose Trolleys	44
Medical Trolleys	45
Storage Cabinets	46
Medium Duty Cabinets	48
Premier BDU Desk Units	49
Beuro Modular Cabinets & Drawers	50
Mesh Door Cabinets	51
Sliding Mesh Door Cabinets	52
Glass Door View Cabinets	53
Sliding Door Cabinets	54
Heavy Duty Cabinets	55
Heavy Duty Mobile Cabinets	55
Heavy Duty Security Cabinets	56
Heavy Duty Roller Shutter Cabinets	57
Metric Storage Lockers	58
Probe Storage Lockers	59
Wire Mesh Lockers	60
Heavy Duty Tough Cubes	61
Plastic Lockers	61
Stainless Steel Equipment	62
Stainless Steel Workbenches	64
Stainless Steel Trolleys	64
Stainless Steel Cabinets & Desk Units	65
Stainless Steel Lockers	66
Terms & Conditions	67

PLANT, EQUIPMENT AND SERVICES

Thanks to our on-going investment programme, our 30,000 sq ft manufacturing, powdercoating, warehousing and office facility in West Yorkshire utilises the very latest plant and equipment to ensure we meet the very highest standards at the most competitive prices. The most up-to-the-minute CNC, CAD and CAM technologies coupled with our

unrivalled engineering skills give us a flexibility and adaptability that few if any of our rivals can match.

We also put great emphasis on product innovation, continually exploring new options and producing new ideas in our drive to give our clients the best possible solution.



In addition to our standard powdercoating we have developed an anti-bacterial coating with active silver ions that penetrate bacteria cell walls and prevent growth. Premiershield, available in a range of colours, is effective against both gram negative and gram positive bacteria. It is recommended as an aid to best hygiene practice in places such as laboratories, schools, public buildings and hospitals.

RESULTS OF INDEPENDENT TESTS

Bacteria tested	% CFU reduction
Staphylococcus Aureus (MRSA)	99.99
Escherichia (e-coli)	99.99
Pseudomonas Aeruginosa	99.99
Bactillus Subtilis	99.98
Salmonella Enteritidis	99.98
Listeria Monocytogenes	99.98

BESPOKE SERVICES

Our bespoke services give us the ability to modify any standard product to meet your particular needs or build to your own design.

STANDARD COLOURS





HAZARDOUS STORAGE





HAZARDOUS CABINETS

COMPLIANT WITH:

- > D S E A R 2002
- > HS(G)51, 1990
- > FACTORY INSPECTORATE CERTIFICATE OF APPROVAL NO1: PARTS 3 & 4
- > COSHH

FLAMMABLE
Cabinet colour:
Yellow RAL 1003

PESTICIDE
Cabinet colour:
Green RAL 6032

FIRST AID
Cabinet colour:
White RAL 9003



PPE
Cabinet colour:
Red RAL 3020

COSHH
Cabinet colour:
Mid Grey RAL 7001

ACID
Cabinet colour:
White RAL 9003

FLAMMABLE
Cabinet colour:
Grey RAL 7031

All cabinets featured are of welded construction, supplied with drip trays and warning labels. Please contact us for any clarification regarding UK guidelines and specifications.



FLAMMABLE STORAGE CABINETS: 88 SERIES

Welded construction in 0.9mm thick steel designed to maintain integrity for 30 minute fire rating. Supplied with adjustable spillage trays and liquid tight sump tray. Doors are rebated and secured by chrome locking handle. High visibility powder coated finish with appropriate warning labels.

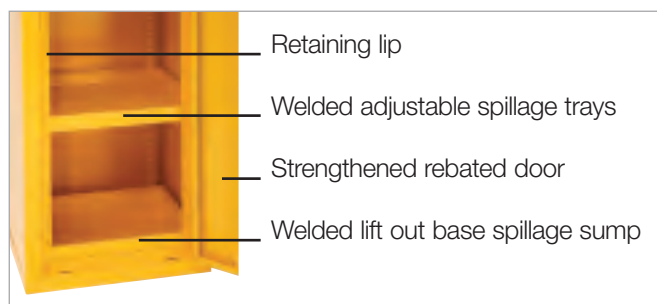

CABINETS

H x W x D(mm)	Code	Shelves	Door	£
712 x 355 x 305	88F733	1	1	144.00
610 x 459 x 459	88F644	1	1	144.00
915 x 459 x 459	88F944	1	1	159.00
1830 x 459 x 459	88F844	3	1	263.80
610 x 610 x 305	88F663	1	2	199.95
712 x 915 x 305	88F793	1	2	199.95
712 x 915 x 459	88F794	1	2	207.85
915 x 915 x 459	88F994	1	2	212.95
1220 x 915 x 459	88F294	2	2	322.00
1525 x 915 x 459	88F594	3	2	354.00
1830 x 915 x 459	88F894	3	2	289.95
1830 x 1220 x 459	88F824	3	2	445.00

88F663 & 88F793 can be used as a wall mounted cabinet

EXTRA SHELVES

W x D(mm)	Code	£
355 x 305	88ES33F	18.75
459 x 459	88ES44F	19.85
610 x 305	88ES63F	22.95
915 x 459	88ES94F	24.95
1220 x 459	88ES24F	28.95

If ordered separately from a cabinet please add £15.00 carriage

SUPPORT STANDS (450mm High)

H x W x D(mm)	Code	Suitable for	£
450 x 459 x 459	88FFS2	88F644, 944	63.32
450 x 915 x 459	88FFS3	88F794, 994, 294	67.46

CASTOR SET (Factory Fitted)

Set of 4x rubber tyred castors fitted.
2x fixed & 2x swivel braked.
Not an option on 1830 cabinets

Diameter(mm)	Code	£
125	C125	74.65

MOBILE FLAMMABLE STORAGE - 81 SERIES

Welded construction from 0.9mm thick sheet steel with double rebated reinforced doors secured by strong 3 way chrome lever locking handle. Fitted with adjustable welded tray(s) and removable sump. Mounted on 2 fixed and 2 swivel braked rubber tyred castors. Supplied with bolt on push / pull handle. Powder coated yellow with appropriate warning labels.

H x W x D(mm)	Code	Shelves	£
900 x 900 x 600	81F996	1	429.44
1200 x 900 x 600	81F296	2	482.34

N.B. Cabinet heights do not include castors.

For overall height including castors please add approx. 180mm.



STOCK FLAMMABLE STORAGE CABINETS

These best-selling sizes are held in stock for rapid delivery.

Welded from 0.9mm steel, they feature strong chrome grab handles, a high visibility powder-coated finish, an appropriate warning label, adjustable perforated spillage trays and a lift-out base spillage sump.

EXTRA SHELVES



CABINETS

H x W x D(mm)	Code	Shelves	Door	£
712 x 355 x 305	88F733	1	1	144.00
915 x 459 x 459	88F944	1	1	159.00
712 x 915 x 459	88F794	1	2	207.85
915 x 915 x 459	88F994	1	2	212.95
1830 x 915 x 459	88F894	3	2	289.95

EXTRA SHELVES

W x D(mm)	Code	£
355 x 305	88ES33F	18.75
459 x 459	88ES44F	19.85
915 x 459	88ES94F	24.95

If ordered separately from a cabinet please add £15.00 carriage

SUPPORT STANDS (450MM HIGH)

H x W x D(mm)	Code	Suitable for	£
450 x 459 x 459	88FFS2	88F944	63.32
450 x 915 x 459	88FFS3	88F794, 88F994G	67.46



Shelf clip included with all shelves



STOCK FLAMMABLE STORAGE CABINETS



88F894
£289.99

88F994
£212.95

88F794
£207.95

88F944
£159.00

88F733
£144.00

- Compliant with:
- D S E A R 2002
 - HS(G)51, 1990
 - Factory Inspectorate Certificate of Approval No1: Parts 3 & 4
 - COSHH
 - Help achieve ISO14001



88F794 Cabinet with 88FFS3 Floor stand
£215.16



88F944 Cabinet with 88FFS2 Floor stand
£223.52

SUPPORT STANDS



88FFS2
£63.32

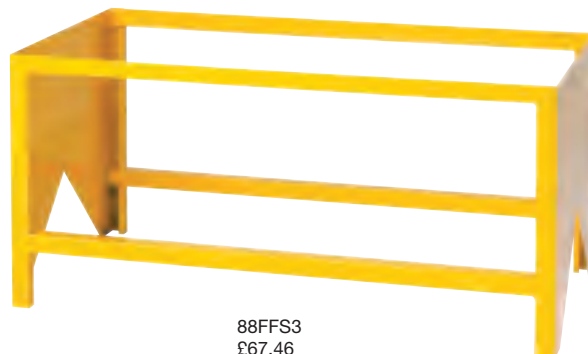

88FFS3
£67.46



GREY FLAMMABLE STORAGE CABINETS: 88 SERIES

Welded construction in 0.9mm thick steel designed to maintain integrity for 30 minute fire rating. Supplied with adjustable spillage trays and liquid tight sump tray. Doors are rebated and secured by chrome 3 way locking handle. Powder coated finish in dark grey with appropriate warning labels.

CABINETS

H x W x D(mm)	Code	Shelves	Door	£
712 x 355 x 305	88F733G	1	1	147.95
610 x 459 x 459	88F644G	1	1	147.95
915 x 459 x 459	88F944G	1	1	162.95
1830 x 459 x 459	88F844G	3	1	265.95
610 x 610 x 305	88F663G	1	2	205.95
712 x 915 x 305	88F793G	1	2	205.95
712 x 915 x 459	88F794G	1	2	209.95
915 x 915 x 459	88F994G	1	2	215.95
1220 x 915 x 459	88F294G	2	2	329.95
1525 x 915 x 459	88F594G	3	2	359.95
1830 x 915 x 459	88F894G	3	2	299.95
1830 x 1220 x 459	88F824G	3	2	449.95

88F663G & 88F793G can be used as a wall mounted cabinet

EXTRA SHELVES

W x D(mm)	Code	£
355 x 305	88ES33FG	18.75
459 x 459	88ES44FG	19.85
610 x 305	88ES63FG	22.95
915 x 459	88ES94FG	24.95
1220 x 459	88ES24FG	28.95

If ordered separately from a cabinet please add £15.00 carriage

SUPPORT STANDS (450MM HIGH)

H x W x D(mm)	Code	Suitable for	£
450 x 459 x 459	88FFSG2	88F644G, 944G	63.32
450 x 915 x 459	88FFSG3	88F794G, 994G, 294G	67.46

CASTOR SET (Factory Fitted)

Set of 4x rubber tyred castors fitted.
2x fixed & 2x swivel braked.
Not an option on 1830 cabinets

Diameter(mm)	Code	£
125	C125	74.65

MOBILE FLAMMABLE STORAGE - 81 SERIES

Welded construction from 0.9mm thick sheet steel with double rebated reinforced doors secured by strong 3 way chrome lever locking handle. Fitted with adjustable welded tray(s) and removable sump. Mounted on 2 fixed and 2 swivel braked rubber tyred castors. Supplied with bolt on push / pull handle. Powder coated grey with appropriate warning labels.

H x W x D(mm)	Code	Shelves	£
900 x 900 x 600	81F996G	1	449.95
1200 x 900 x 600	81F296G	2	499.95

N.B. Cabinet heights do not include castors.
For overall height including castors please add approx. 180mm.

FLAMMABLE STORAGE

Safety cabinet with a robust welded construction. Fitted internally with welded spillage tray(s) and lift out base spillage sump. Grey with labels.



- Compliant with:
- D S E A R 2002
 - HS(G)51, 1990
 - Factory Inspectorate Certificate of Approval No1: Parts 3 & 4
 - COSHH



MOBILE GREY FLAMMABLE STORAGE - 81 SERIES



STAINLESS STEEL HAZARDOUS CABINETS: 87 SERIES

Welded and riveted construction from 304 quality stainless steel sheet with a brushed polish finish. Manufactured with reinforced doors mounted on pin hinges secured by flush mounted three way locking handle. Fitted internally with adjustable spillage trays and lift out sump. Complete with warning label



- ADJUSTABLE SPILLAGE TRAYS
- BASE SPILLAGE SUMP
- SUPPLIED WITH APPROPRIATE LABEL
- 304 QUALITY STAINLESS STEEL

CABINETS

H x W x D(mm)	Code	Shelves	Door	£
1800 x 880 x 450	87F884	3	2	995.95
1200 x 880 x 450	87F284	2	2	841.81
900 x 880 x 450	87F984	1	2	766.46
900 x 450 x 450	87F944	1	2	480.63

EXTRA SHELVES

W x D(mm)	Code	£
450 x 450	87ES44F	39.60
880 x 450	87ES84F	67.20

If ordered separately from a cabinet please add £15.00 carriage

Compliant with:

- D S E A R 2002
- HS(G)51, 1990
- Factory Inspectorate Certificate of Approval No1: Parts 3 & 4
- COSHH



STAINLESS STEEL PRODUCTS START ON PAGE 62



Stainless Steel Pages 62-66



Workbenches Page 64



Trolleys Page 64



Lockers Page 66



Cabinets Page 65

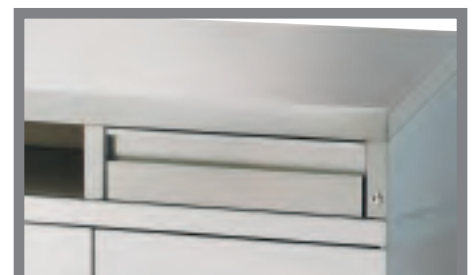

Desk Units Page 65



COSHH CABINETS: 88 SERIES

Comprehensive range of COSHH cabinets for the safe storage and segregation of substances that are labelled as being hazardous to health, for example Toxic or Irritant. Based on employers carrying out mandatory risk assessments COSHH cabinets can aid as a precaution, control and maintenance of control elements of the COSHH Regulations 2002. Welded construction from 0.9mm thick steel with reinforced rebated door(s). Secured by 3 way chrome lever locking handle.

CABINETS

H x W x D(mm)	Code	Shelves	Door	£
712 x 355 x 305	88H733	1	1	147.95
610 x 459 x 459	88H644	1	1	147.95
915 x 459 x 459	88H944	1	1	162.95
1830 x 459 x 459	88H844	3	1	265.95
610 x 610 x 305	88H663	1	2	205.95
712 x 915 x 305	88H793	1	2	205.95
712 x 915 x 459	88H794	1	2	209.95
915 x 915 x 459	88H994	1	2	215.95
1220 x 915 x 459	88H294	2	2	329.95
1525 x 915 x 459	88H594	3	2	359.95
1830 x 915 x 459	88H894	3	2	299.95
1830 x 1220 x 459	88H824	3	2	449.95

88H663 & 88H793 can be used as a wall mounted cabinet

EXTRA SHELVES

W x D(mm)	Code	£
355 x 305	88ES33H	18.75
459 x 459	88ES44H	19.85
610 x 305	88ES63H	22.95
915 x 459	88ES94H	24.95
1220 x 459	88ES24H	28.95

If ordered separately from a cabinet please add £15.00 carriage

SUPPORT STANDS (450MM HIGH)

H x W x D(mm)	Code	Suitable for	£
450 x 459 x 459	88HF2	88H644, 944	63.32
450 x 915 x 459	88HFS3	88H794, 994, 294	67.46

CASTOR SET (Factory Fitted)

Set of 4x rubber tyred castors fitted.
2x fixed & 2x swivel braked.
Not an option on 1830 cabinets

Diameter(mm)	Code	£
125	C125	74.65

MOBILE COSHH STORAGE - 81 SERIES

Welded construction from 0.9mm thick sheet steel with double rebated reinforced doors secured by strong 3 way chrome lever locking handle. Fitted with adjustable welded tray(s) and removable sump. Mounted on 2 fixed and 2 swivel braked rubber tyred castors. Supplied with bolt on push / pull handle. Powder coated grey with appropriate warning labels.

H x W x D(mm)	Code	Shelves	£
900 x 900 x 600	81H996	1	449.95
1200 x 900 x 600	81H296	2	499.95

N.B. Cabinet heights do not include castors.

For overall height including castors please add approx. 180mm.

HAZARDOUS STORAGE

Safety cabinet with a robust welded construction. Fitted internally with welded spillage tray(s) and lift out base spillage sump. Mid grey with labels.



Compliant with:
• COSHH regulations 2002

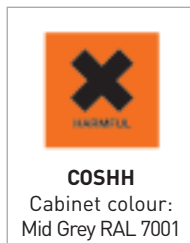

MOBILE COSHH STORAGE - 81 SERIES



ACID & ALKALI CABINETS: 88 SERIES

Welded construction in 0.9mm thick zintec steel for extra corrosive resistance designed to store acids safely. Supplied with adjustable spillage trays and liquid tight sump tray. Doors are rebated and secured by chrome 3 way locking handle. High visibility powder coated finish with appropriate warning labels. Note that these cabinets are for storing acids safely and do not claim to be acid proof. It is recommended that acids are stored in their original containers with the lids in the closed position

ACID STORAGE

Safety cabinet with a robust welded construction. Fitted internally with welded spillage tray(s) and lift out base spillage sump. White with labels.



CABINETS

H x W x D(mm)	Code	Shelves	Door	£
712 x 355 x 305	88A733	1	1	180.45
610 x 459 x 459	88A644	1	1	180.45
915 x 459 x 459	88A944	1	1	182.51
1830 x 459 x 459	88A844	3	1	297.95
610 x 610 x 305	88A663	1	2	227.95
712 x 915 x 305	88A793	1	2	241.95
712 x 915 x 459	88A794	1	2	235.57
915 x 915 x 459	88A994	1	2	255.60
1220 x 915 x 459	88A294	2	2	386.39
1525 x 915 x 459	88A594	3	2	405.21
1830 x 915 x 459	88A894	3	2	353.64
1830 x 1220 x 459	88A824	3	2	481.50

88A663 & 88A793 can be used as a wall mounted cabinet

EXTRA SHELVES

W x D(mm)	Code	£
355 x 305	88ES33A	19.75
459 x 459	88ES44A	20.85
610 x 305	88ES63A	23.95
915 x 459	88ES94A	24.95
1220 x 459	88ES24A	29.95

If ordered separately from a cabinet please add £15.00 carriage

SUPPORT STANDS (450MM HIGH)

H x W x D(mm)	Code	Suitable for	£
450 x 459 x 459	88AF2	88A644, 944	69.30
450 x 915 x 459	88AFS3	88A794, 994, 294	73.60

CASTOR SET (Factory Fitted)

Set of 4x rubber tyred castors fitted.
2x fixed & 2x swivel braked.
Not an option on 1830 cabinets

Diameter(mm)	Code	£
125	C125	74.65

MOBILE FLAMMABLE STORAGE - 81 SERIES

Welded construction from 0.9mm thick zintec coated sheet steel for extra corrosive resistance. Double rebated reinforced doors secured by strong 3 way chrome lever locking handle. Fitted with adjustable welded tray(s) and removable sump. Mounted on 2 fixed and 2 swivel braked rubber tyred castors. Supplied with bolt on push / pull handle. Powder coated white with appropriate warning labels.

H x W x D(mm)	Code	Shelves	£
900 x 900 x 600	81A996	1	549.95
1200 x 900 x 600	81A296	2	599.95

N.B. Cabinet heights do not include castors.

For overall height including castors please add approx. 180mm.

MOBILE ACID/ALKALI STORAGE - 81 SERIES



Compliant with:
• COSHH - 1994



AGROCHEMICAL & PESTICIDE CABINETS: 88 SERIES

Welded construction in 0.9mm thick zintec steel with ventilated doors. Supplied with adjustable spillage trays and liquid tight sump tray. Doors are rebated and secured by chrome 3 way locking handle. High visibility powder coated finish with appropriate warning labels.

CABINETS

H x W x D(mm)	Code	Shelves	Door	£
712 x 355 x 305	88P733	1	1	190.45
610 x 459 x 459	88P644	1	1	190.45
915 x 459 x 459	88P944	1	1	192.51
1830 x 459 x 459	88P844	3	1	297.95
610 x 610 x 305	88P663	1	2	227.95
712 x 915 x 305	88P793	1	2	241.95
712 x 915 x 459	88P794	1	2	235.57
915 x 915 x 459	88P994	1	2	255.60
1220 x 915 x 459	88P294	2	2	386.39
1525 x 915 x 459	88P594	3	2	405.21
1830 x 915 x 459	88P894	3	2	353.64
1830 x 1220 x 459	88P824	3	2	489.50

88P663 & 88P793 can be used as a wall mounted cabinet

EXTRA SHELVES

W x D(mm)	Code	£
355 x 305	88ES33P	19.75
459 x 459	88ES44P	20.85
610 x 305	88ES63P	23.95
915 x 459	88ES94P	24.95
1220 x 459	88ES24P	29.95

If ordered separately from a cabinet please add £15.00 carriage

SUPPORT STANDS (450MM HIGH)

H x W x D(mm)	Code	Suitable for	£
450 x 459 x 459	88PF2	88P644, 944	69.30
450 x 915 x 459	88PFS3	88P794, 994, 294	73.60

CASTOR SET (Factory Fitted)

Set of 4x rubber tyred castors fitted.
2x fixed & 2x swivel braked.
Not an option on 1830 cabinets

Diameter(mm)	Code	£
125	C125	74.65

MOBILE AGROCHEMICAL / PESTICIDE STORAGE - 81 SERIES

Welded construction from 0.9mm thick zintec coated sheet steel for extra corrosive resistance. Double rebated reinforced doors secured by strong 3 way chrome lever locking handle. Doors are both ventilated. Fitted with adjustable welded tray(s) and removable sump. Mounted on 2 fixed and 2 swivel braked rubber tyred castors. Supplied with bolt on push / pull handle. Powder coated green with appropriate warning labels.

H x W x D(mm)	Code	Shelves	£
900 x 900 x 600	81P996	1	549.95
1200 x 900 x 600	81P296	2	599.95

N.B. Cabinet heights do not include castors.

For overall height including castors please add approx. 180mm.

PESTICIDE STORAGE

Safety cabinet with a robust welded construction. Fitted internally with welded spillage tray(s) and lift out base spillage sump. Green with labels.

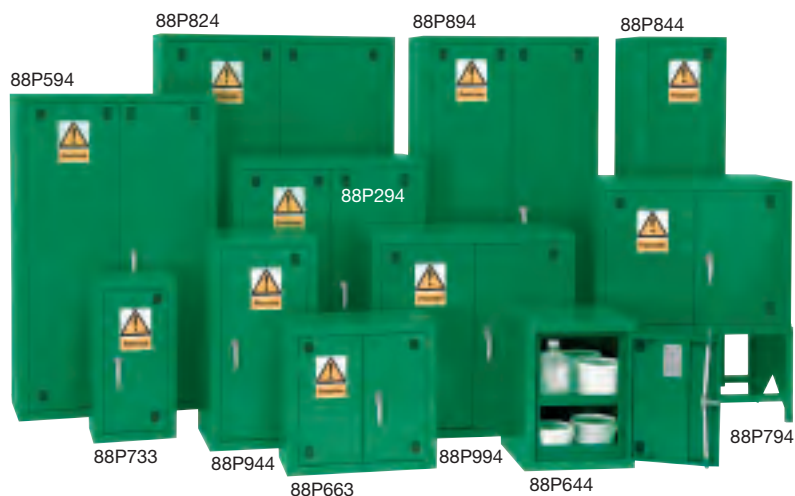

- Compliant with:
- HSE Guidance Notes A.I.S.16
 - Control of pesticide regulations 1986
 - COSHH - 1994



MOBILE AGROCHEMICAL / PESTICIDE STORAGE - 81 SERIES



FIRST AID CABINETS

High visibility first aid cabinets of welded construction from 0.9mm thick steel with adjustable shelves. Reinforced rebated doors secured by 3 way locking chrome handle. Finished powder coated white and supplied with first aid labels

FIRST AID STORAGE

Safety cabinet with a robust welded construction. White with labels.



CABINETS

H x W x D(mm)	Code	Shelves	Door	£
712 x 355 x 305	88FA733	1	1	144.00
610 x 459 x 459	88FA644	1	1	144.00
915 x 459 x 459	88FA944	1	1	159.00
1830 x 459 x 459	88FA844	3	1	263.80
610 x 610 x 305	88FA663	1	2	199.95
712 x 915 x 305	88FA793	1	2	199.95
712 x 915 x 459	88FA794	1	2	207.85
915 x 915 x 459	88FA994	1	2	212.95
1220 x 915 x 459	88FA294	2	2	322.00
1525 x 915 x 459	88FA594	3	2	354.00
1830 x 915 x 459	88FA894	3	2	289.95
1830 x 1220 x 459	88FA824	3	2	445.00

88FA663 88FA793 can be used as a wall mounted cabinet

EXTRA SHELVES

W x D(mm)	Code	£
355 x 305	88ES33FA	18.75
459 x 459	88ES44FA	19.85
610 x 305	88ES63FA	22.95
915 x 459	88ES94FA	24.95
1220 x 459	88ES24FA	28.95

If ordered separately from a cabinet please add £15.00 carriage

SUPPORT STANDS (450MM HIGH)

H x W x D(mm)	Code	Suitable for	£
450 x 459 x 459	88FAS2	88FA644, 944	63.32
450 x 915 x 459	88FAS3	88FA794, 994, 294	67.46

MOBILE FIRST AID STORAGE - 81 SERIES



Compliant with:
• Health & Safety regulations 1981



FIRST AID
Cabinet colour:
White RAL 9003

CASTOR SET (Factory Fitted)

Set of 4x rubber tyred castors fitted.
2x fixed & 2x swivel braked.
Not an option on 1830 cabinets

Diameter(mm)	Code	£
125	C125	74.65

MOBILE FIRST AID STORAGE - 81 SERIES

Welded construction from 0.9mm thick sheet steel with double rebated reinforced doors secured by strong 3 way chrome lever locking handle. Fitted with adjustable shelves. Mounted on 2 fixed and 2 swivel braked rubber tyred castors. Supplied with bolt on push / pull handle. Powder coated white with appropriate warning labels.

H x W x D(mm)	Code	Shelves	£
900 x 900 x 600	81A996	1	549.95
1200 x 900 x 600	81A296	2	599.95

N.B. Cabinet heights do not include castors.

For overall height including castors please add approx. 180mm.

WALL MOUNTED CABINETS

H x W x D(mm)	Code	£
450 x 380 x 250	82432FA	197.00
800 x 800 x 260	82882FA	391.11

EXTRA SHELVES

380 x 250	82S32FA	19.80
800 x 260	82S82FA	28.95

If ordered separately from a cabinet please add £15.00 carriage

FIRST AID TROLLEYS SEE PAGE 45

FIRST AID STORAGE

Welded construction from 2mm thick steel secured by 5 lever mortice lock(s). Supplied with appropriate warning labels.



PPE CABINETS: 88 SERIES

Welded construction in 0.9mm steel to provide a robust steel cabinet to protect PPE from damage, contamination or loss. The 1525 & 1830mm high model is complete with centre divider, 3 adjustable shelves and hanging rail. Other sizes complete with adjustable shelves.

CABINETS

H x W x D(mm)	Code	Shelves	Door	£
712 x 355 x 305	88E733	1	1	144.00
610 x 459 x 459	88E644	1	1	144.00
915 x 459 x 459	88E944	1	1	159.00
1830 x 459 x 459	88E844	3	1	263.80
610 x 610 x 305	88E663	1	2	199.95
712 x 915 x 305	88E793	1	2	199.95
712 x 915 x 459	88E794	1	2	207.85
915 x 915 x 459	88E994	1	2	212.95
1220 x 915 x 459	88E294	2	2	322.00
1525 x 915 x 459	88E594	3	2	354.00
1830 x 915 x 459	88E894	3	2	411.96
1830 x 1220 x 459	88E824	3	2	445.00
1830 x 915 x 459	88E894MD	3	2	402.55

88E663 & 88E793 can be used as a wall mounted cabinet

EXTRA SHELVES

W x D(mm)	Code	£
355 x 305	88ES33E	18.75
459 x 459	88ES44E	19.85
610 x 305	88ES63E	22.95
915 x 459	88ES94E	24.95
1220 x 459	88ES24E	28.95

If ordered separately from a cabinet please add £15.00 carriage

SUPPORT STANDS (450MM HIGH)

H x W x D(mm)	Code	Suitable for	£
450 x 459 x 459	88EFS2	88EF644, 944	63.32
450 x 915 x 459	88EFS3	88EF794, 994, 294	67.46

CASTOR SET (Factory Fitted)

Set of 4x rubber tyred castors fitted.
2x fixed & 2x swivel braked.
Not an option on 1830 cabinets

Diameter(mm)	Code	£
125	C125	74.65

PPE STORAGE

Safety cabinet with a robust welded construction.

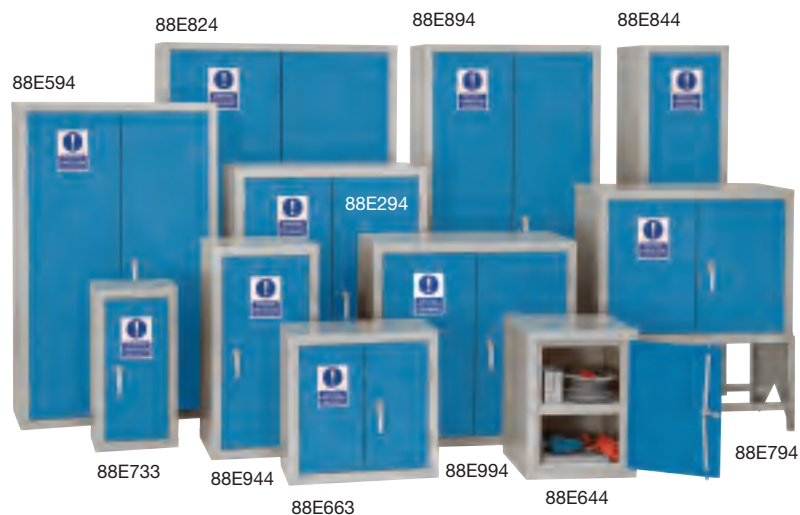

Compliant with:
• The Personal Protective Equipment at Work Regulations 1994



PERSONAL PROTECTION EQUIPMENT

PPE

Cabinet colour:
Mid Grey 7001
Door colour:
Blue RAL 5015



88E894MD

HEAVY DUTY HAZARDOUS STORAGE CABINETS

All cabinets on this page are compliant with:-
D S E A R 2002-HS(G)51, 1990-Factory Inspectorate
Certificate of Approval No1: Parts 3 & 4-COSHH

HEAVY DUTY SAFETY CABINETS - 57 SERIES

Welded construction in 2mm steel plate with sealed base drainage boss. Reinforced doors mounted on pin hinge, secured by mortise lock. Shelves are adjustable. Finished powder coated red with appropriate warning labels.



57226

HEAVY DUTY - 57 SERIES

H x W x D(mm)	Code	£
SINGLE DOOR		
900 x 600 x 450	57964	399.24
1200 x 600 x 450	57264	472.44
1500 x 900 x 450	57594	599.95
DOUBLE DOOR		
900 x 900 x 450	57994	599.95
1200 x 1200 x 600	57226	699.95
1500 x 1500 x 600	57556	799.95
Hi Lo Vents		49.95

HEAVY DUTY - 85 SERIES

H x W x D(mm)	Code	*H £	*C £
600 x 450 x 450	85644*	159.95	189.95
900 x 450 x 450	85944*	199.95	229.95
700 x 900 x 450	85794*	329.95	359.95
900 x 900 x 450	85994*	359.95	389.95
1200 x 900 x 450	85294*	394.95	429.95
1500 x 900 x 450	85594*	449.95	479.95
1800 x 900 x 450	85894*	499.95	529.95

WALL CABINET

600 x 450 x 250	85642*	162.45	154.13
900 x 450 x 250	85942*	195.95	184.69

* Add H (RED) or C (GREY) to order code to indicate colour required

YELLOW HEAVY DUTY- 85 SERIES

H x W x D(mm)	Code	£
1800 x 900 x 450	85Y894	499.95

HEAVY DUTY CHEMICAL CABINETS - 85 SERIES & HEAVY DUTY HAZARDOUS CABINETS - 85 SERIES

Constructed in 1.2mm thick steel sheet with sealed base and lift out sump. Reinforced doors mounted on continuous hinge. Flush 3 way locking handle. Adjustable spillage shelves. Standard colour finish red. Chemical cabinets constructed in 1.2mm zintec steel finished grey.



WORKBENCHES





PREMIER 1 WORKBENCH RANGE

A flat pack modular workbench system with a weight capacity of 450kg UDL. All workbenches are 840mm high as standard, other heights available. All Premier workbench frames, cabinet and drawer carcasses are epoxy polyester powder coated in Mid Grey RAL 7001. All premier cabinet doors and drawers are epoxy polyester powder coated in Premier Blue.

WORKTOPS

- A = 30mm thick hardwood veneer top.
- B = 30mm thick industrial marble grey lino.
- C = 25mm thick plain cut MDF.

WORKBENCHES

L x W(mm)	Top	Code	£
1500 x 600	Veneer	PW156A	197.18
1500 x 700	Veneer	PW157A	233.65
1500 x 600	Lino	PW156B	245.78
1500 x 700	Lino	PW157B	287.13
1500 x 600	MDF	PW156C	163.35
1500 x 700	MDF	PW157C	200.26
2000 x 600	Veneer	PW126A	240.31
2000 x 700	Veneer	PW127A	284.19
2000 x 600	Lino	PW126B	301.32
2000 x 700	Lino	PW127B	360.34
2000 x 600	MDF	PW126C	209.70
2000 x 700	MDF	PW127C	250.18

ACCESSORIES

L x W(mm)	Description	Code	£
1500 x 600	Base Shelf	PW156BS	46.66
1500 x 600	Base Shelf / Mat	PW156BM	87.20
1500 x 700	Base Shelf	PW157BS	51.35
1500 x 700	Base Shelf / Mat	PW157BM	91.87
2000 x 600	Base Shelf	PW126BS	62.29
2000 x 600	Base Shelf / Mat	PW126BM	106.32
2000 x 700	Base Shelf	PW127BS	68.42
2000 x 700	Base Shelf / Mat	PW127BM	114.74

CASTOR SET (Factory Fitted)

Set of 4x rubber tyred castors fitted. 2x fixed & 2x swivel braked. (300Kg UDL capacity)

Diameter(mm)	Code	£
100	PW4SC	66.07

CABINETS

H / Drawer(mm)	Code	Shelves	Drawers	£
	PC1	2		204.79
150	PC2	1	1	251.19
150/100	PC4		3/1	410.63

DRAWERS

H(mm)	Drawers	Code	£
150	1	PD1A	155.85
350	1	PD1B	190.61
150	2	PD2	272.72

PREMIER 1 WORKBENCH RANGE

Simple flat pack assembly for a basic bench 600mm wide including all assembly fixings



1500 x 600 c/w lino worktop
PW156B £245.78

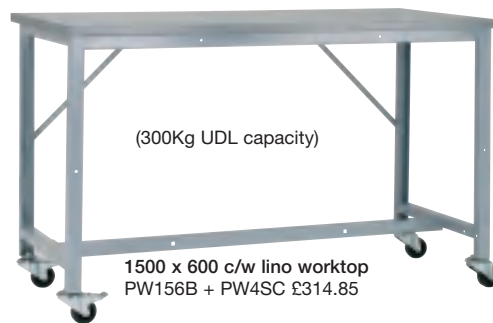

1500 x 600 c/w lino worktop
PW156B + PW4SC £314.85

All cabinets & drawers have central locking facility and are manufactured from 0.9mm thick steel sheet.

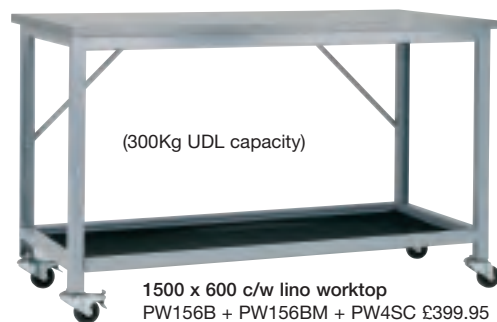

1500 x 600 c/w lino worktop
PW156B + PW156BM + PW4SC £399.95

PREMIER UNDERBENCH CABINETS

650mm high, 500mm wide & 500mm deep. All cabinets secured by semi-flush fit locking handle and come complete with perforated tool panel and adjustable shelf.



PC1

PC2

PC4

PREMIER UNDERBENCH DRAWERS

500mm wide x 500mm deep.
PD1A = 225mm high PD1B = 425mm high
All drawers are mounted on precision ball bearing telescopic slides (capacity 40kg UDL)



PD1A

PD1B

PD2



If not standard, please specify colour choice at time of order

PREMIER 1 WORKBENCH RANGE



1500 x 600 c/w veneer worktop
PW156A + PW156BM £284.38



1500 x 600 c/w veneer worktop
PW156A + PC1 £401.99



1500 x 600 c/w lino worktop
PW156B + PC2 £496.96

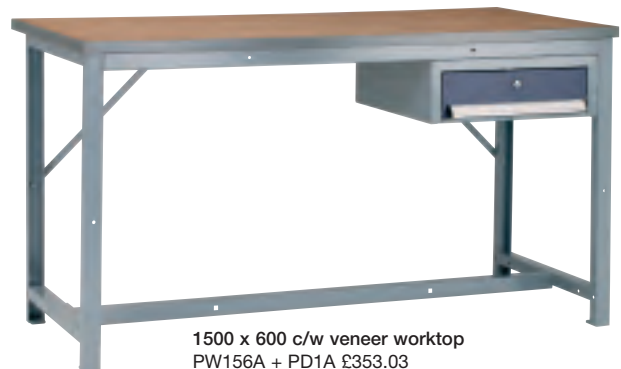

1500 x 600 c/w veneer worktop
PW156A + PD1A £353.03



1500 x 600 c/w lino worktop
PW156B + PC4 £656.41



1500 x 600 c/w lino worktop
PW156B + PD1A £401.63



1500 x 600 c/w lino worktop
PW156B + PD2 £518.50



1500 x 600 c/w veneer worktop
PW156A + PD1A + PC1 £557.90

450KG UDL

Construction from fabricated steel section with welded leg supports and multi position cross rail.



If not standard, please specify colour choice at time of order



PREMIER 2 WORKBENCH RANGE

A flat pack heavy duty modular workbench system with a weight capacity of 700kg UDL. All workbenches are 840mm high as standard, other heights available on request. All Premier workbench frames are epoxy polyester powder coated in Mid Grey RAL 7001. Cabinets/drawers Premier Blue.

WORKTOPS

- A = 30mm thick hardwood veneer top.
- B = 30mm thick industrial marble grey lino.
- C = 25mm thick plain cut MDF.

WORKBENCHES

L x W(mm)	Top	Code	£
1500 x 700	Veneer	PW257A	255.49
1500 x 700	Lino	PW257B	306.03
1500 x 700	MDF	PW257C	225.41
2000 x 700	Veneer	PW227A	300.97
2000 x 700	Lino	PW227B	380.94
2000 x 700	MDF	PW227C	261.67

CABINETS

H / Drawer(mm)	Code	Shelves	Drawers	£
	PC1	2		204.79
150	PC2	1	1	251.19
150/100	PC4		3/1	410.63

DRAWERS

H(mm)	Drawers	Code	£
150	1	PD1A	155.85
350	1	PD1B	190.61
150	2	PD2	272.72

ACCESSORIES

ACCESSORY POSTS

PWAP1	1000mm high to accommodate combination back panel	£56.32
PWAP2	1500mm high to accommodate back panel and upper shelf	£60.78
PWAP3	2000mm high to accommodate back panel, upper shelf and light	£65.21

SERVICE DUCT

PWSD15	1500mm long service duct with 2 x 2 13amp double sockets	£68.11
PWSD20	2000mm long service duct with 2 x 2 13amp double sockets	£71.56

COMBINATION BACK PANELS 450MM HIGH

PWCP15	1500mm long back panel 1/2 louvred 1/2 perforated	£78.14
PWCP20	2000mm long back panel 1/2 louvred 1/2 perforated	£107.55

UPPER SHELVES

PWUSS15	1500mm long steel upper shelf	£54.26
PWUSS20	2000mm long steel upper shelf	£65.46

LIGHT BAR WITH 1200MM STRIP LIGHT*

PWLU15	1500mm long supplied with diffuser	£96.10
PWLU20	2000mm long supplied with diffuser	£108.39

*All electrics are supplied unwired, for fitting by a suitably qualified electrician

PREMIER 2 WORKBENCHES

HEIGHT

All workbenches 840mm high.

AVAILABLE IN 2 SIZES

1500mm length x 700mm wide
2000mm length x 700mm wide

3 WORKTOPS

- A = 30mm thick Veneer
- B = 30mm thick Lino
- C = 25mm thick plain cut MDF



1500 x 700 c/w lino worktop
PW257B + PC2 + AP3 + SD15 + USS15 + LU15
£955.97



1500 x 700 c/w lino worktop
PW257B + AP3 + SD15 + LP15 + USS15 + LU15
£704.18

PREMIER UNDERBENCH CABINETS

650mm high, 500mm wide & 500mm deep.
All cabinets secured by semi-flush fit locking handle and come complete with perforated tool panel and adjustable shelf.



PC1

PC2

PC4

PREMIER UNDERBENCH DRAWERS

500mm wide x 500mm deep.
PD1A = 225mm high PD1B = 425mm high
All drawers are mounted on precision ball bearing telescopic slides (capacity 40kg UDL)



PD1A

PD1B

PD2



If not standard, please specify colour choice at time of order



WELDING WORKBENCH RANGE

A range of Flat Pack Heavy Duty Welding Workbench system with a weight capacity of 700kg UDL. All workbenches are 840mm high as standard, other heights available on request.

**PREMIER 2 TYPE WELDING BENCH
1500 X 700 X 840 - PWB257FBSL**



£349.99

Heavy Duty Framework designed to meet the toughest of environments.

Its rugged construction is well suited to industrial and educational use is maintenance free.

Option 1 - 1/2 refractory fire brick - 1/2 slatted worktop.

Flat pack - ideal for export.



1500 x 700 c/w lino worktop
PW257B
£306.03



1500 x 700 c/w lino worktop
PW257B + PD1A + PC1

**PREMIER 2 TYPE WELDING BENCH
1500 X 700 X 840 - PWB257FBST**

Heavy Duty Framework designed to meet the toughest of environments.

Option 1 - 1/2 refractory fire brick - 1/2 steel worktop.

Flat pack - ideal for export.

£349.99



**PREMIER 2 TYPE WELDING BENCH
1500 X 700 X 840 - PWB257STSL**



£349.99

Heavy Duty Framework designed to meet the toughest of environments.

Its rugged construction is well suited to industrial and educational use is maintenance free.

Option 1 - 1/2 steel - 1/2 slatted worktop.

Flat pack - ideal for export.



1500 x 700 c/w lino worktop
PW257B + PC2
£557.22



PREMIER 3 SQUARE TUBE & PREMIER 4 CANTILEVER WORKBENCHES

Welded construction from 30mm thick square and rectangular tube steel with a choice of worktops & accessories. The benches will arrive on site built up with above the work surface accessories supplied loose. All workbenches are 840mm high as standard, other heights available. Mid Grey RAL 7001 Frames with Premier Blue Doors/Drawers.

ACCESSORY POSTS

PAP1	1000mm high to accommodate combination back panel	£56.32
PAP2	1500mm high to accommodate back panel & upper shelf	£60.78
PAP3	2000mm high to accommodate back panel, upper shelf & light	£65.21

SERVICE DUCT*

PSD15	1500mm long service duct with 2 x 2 13amp plug sockets	£68.11
PSD18	1800mm long service duct with 2 x 2 13amp plug sockets	£71.56

COMBINATION BACK PANELS 450MM HIGH

PCP15	1500mm long back panel louvred & perforated	£78.14
PCP18	1800mm long back panel louvred & perforated	£97.55

UPPER SHELVES

PUSS15	1500mm long steel upper shelf	£54.26
PUSS18	1800mm long steel upper shelf	£65.46

BASE SHELVES

PBS15	1500mm long steel base shelf	£71.15
PBS18	1800mm long steel base shelf	£77.06

LIGHT BAR WITH 1200MM STRIP LIGHT*

PLU15	1500mm long supplied with diffuser	£96.10
PLU18	1800mm long supplied with diffuser	£98.39

*All electrics are supplied unwired, for fitting by a suitably qualified electrician

WORKTOPS

A = 18mm thick hardwood veneer. 2mm veneer surface on 16mm composite core. Edge banded in 2mm thick grey plastic
 B = 18mm thick industrial marble grey lino. 2mm veneer surface on 16mm composite core. Edge banded in 2mm thick grey plastic

WORKBENCHES (Square Tube)

L x W(mm)	Top	Code	£
1500 x 600	Veneer	PW356A	312.35
1500 x 750	Veneer	PW357A	359.24
1500 x 600	Lino	PW356B	312.17
1500 x 750	Lino	PW357B	333.15
1800 x 600	Veneer	PW386A	312.13
1800 x 750	Veneer	PW387A	356.90
1800 x 600	Lino	PW386B	318.30
1800 x 750	Lino	PW387B	336.42

WORKBENCHES (Cantilever)

L x W(mm)	Top	Code	£
1500 x 600	Veneer	PW456A	334.64
1500 x 750	Veneer	PW457A	389.60
1500 x 600	Lino	PW456B	344.58
1500 x 750	Lino	PW457B	364.65
1800 x 600	Veneer	PW486A	344.54
1800 x 750	Veneer	PW487A	387.34
1800 x 600	Lino	PW486B	350.44
1800 x 750	Lino	PW487B	367.79

CABINETS

H / Drawer(mm)	Code	Shelves	Drawers	£
	PC1	2		204.79
150	PC2	1	1	351.19
150/100	PC4		3/1	410.63

DRAWERS

H(mm)	Drawers	Code	£
150	1	PD1A	155.85
350	1	PD1B	190.61
150	2	PD2	272.72

PREMIER 3 SQUARE TUBE & PREMIER 4 CANTILEVER WORKBENCHES



1800 x 750 c/w lino worktop
 Order code: PW387B +
 PC2 Cabinet / drawer
 PSD18 Service duct*
 PAP3 Accessory posts
 PCP18 Combination panel
 PUSS18 Upper shelf
 PLU18 Light bar*

PRICE £879.67



1800 x 750 c/w lino worktop
 Order code: PW487B +
 PC2 Cabinet / drawer
 PSD18 Service duct*
 PAP3 Accessory posts
 PCP18 Combination panel
 PUSS18 Upper shelf
 PLU18 Light bar*

PRICE £908.59
 bins & clips not inc.

PREMIER UNDERBENCH CABINETS

650mm high, 500mm wide & 500mm deep.
 All cabinets secured by semi-flush fit locking handle and come complete with perforated tool panel and adjustable shelf.



PC1

PC2

PC4

PREMIER UNDERBENCH DRAWERS

500mm wide x 500mm deep.
 PD1A = 225mm high PD1B = 425mm high
 All drawers are mounted on precision ball bearing telescopic slides (capacity 40kg UDL)



PD1A

PD1B

PD2



If not standard, please specify colour choice at time of order



PREMIER MODULAR PEDESTAL WORKBENCHES

Flat pack modular workbench system offering a variety of storage and workspace solutions. Leg frames are constructed from fabricated steel section to bolt to the worktop. 650mm high premier units are mounted on 150mm high steel plinths. All cabinets are lockable and contain 1 adjustable shelf. All drawers are mounted on precision ball bearing telescopic slides offering a 40Kg (UDL) capacity. Mid Grey RAL 7001 Frames with Red 3020 Doors/Drawers.

WORKBENCHES

1500mm Length x 600mm Wide

Combination	Code	£
PLU600+PPC1+W56B	Model 1	390.61
PLU600+PPC2+W56B	Model 2	437.01
PLU600+PPC4+W56B	Model 3	596.45
PPC4+PPC1+W56B	Model 4	775.48
PPC4+PPC4+W56B	Model 5	981.30
PPC4+PPC2+W56B	Model 6	821.86
PPC2+PPC2+W56B	Model 7	662.42
PPC4+PPC4+PPC4+W56B	Model 8	1479.93
PPC2+PPC2+PPC4+W56B	Model 9	1124.37

3000mm Length x 600mm Wide

Combination	Code	£
PPC1+PPC4+PPC2+W56B+W56B	Model 10	1,153.70
PPC1x2+PPC2x2+PPC4x2+W56Bx2	Model 11	2,155.66

WORKTOPS

H x W x D(mm)	Top	Code	£
30 x 1500 x 600	Veneer	W56A	87.03
30 x 2000 x 600	Veneer	W26A	96.75
30 x 1500 x 600	Lino	W56B	94.07
30 x 2000 x 600	Lino	W26B	158.63

ACCESSORIES

H x W x D(mm)	Description	Code	£
800 x N/A x 500	Leg Unit	PLU600	58.76
800 x 500 x 500	Cabinet	PPC1	237.78
800 x 500 x 500	Cabinet / Drawer	PPC2	284.02
800 x 500 x 500	4 Drawer Unit	PPC4	461.96

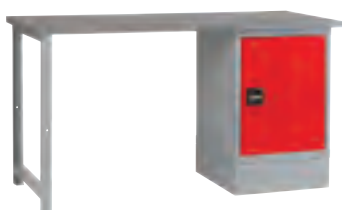

MODEL 1: PLU600 + PPC1 + W56B
£390.61



MODEL 2: PLU600 + PPC2 + W56B
£437.01

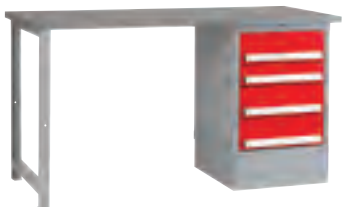

MODEL 3: PLU600 + PPC4 + W56B
£596.45



MODEL 4: PPC4 + PPC1 + W56B
£775.48

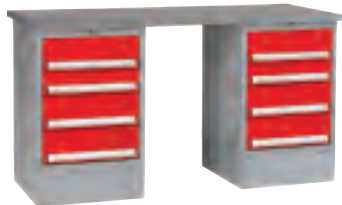

MODEL 5: PPC4 + PPC4 + W56B
£981.30



MODEL 6: PPC4 + PPC2 + W56B
£821.86



MODEL 7: PPC2 + PPC2 + W56B
£662.42

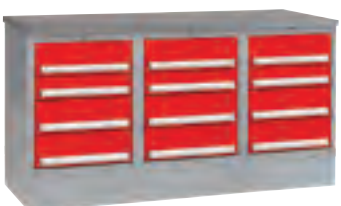

MODEL 8: PPC4 + PPC4 + PPC4 + W56B
£1479.93



MODEL 9: PPC2 + PPC2 + PPC4 + W56B
£1124.37

Create a run... Choose your size, storage option, worktop and go.
All benches are 830mm high. Mid grey (RAL 7001) carcass with colour choice drawers/doors



MODEL 10: PPC1 + PPC4 + PPC2 + W56B + W56B x2
£1,153.70



MODEL 11: PPC1 x2 + PPC2 x2 + PPC4 x2 + W56B x2
£2,155.66



PREM-ECON 1 MEDIUM DUTY WORKBENCHES

Taking the Bedford Premier flat pack workbench frame and adding the standard Bedford underbench storage units makes for a quality yet economic workbench solution. Constructed from fabricated steel section with welded leg supports and multiposition cross rail. Framework powder coated Mid grey RAL 7001 with Blue RAL 5015 doors and drawers front colour.

WORKBENCHES

L x W(mm)	Top	Code	£
1500 x 700	Veneer	PEW157A	233.65
1500 x 700	Lino	PEW157B	287.13
1500 x 700	MDF	PEW157C	200.26
2000 x 700	Veneer	PEW127A	284.19
2000 x 700	Lino	PEW127B	360.34
2000 x 700	MDF	PEW127C	250.18

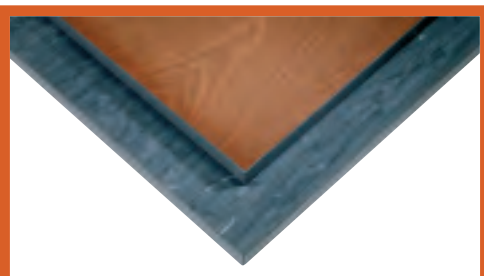

WORKTOPS

- A = 30mm thick hardwood veneer top.
- B = 30mm thick industrial marble grey lino.
- C = 25mm thick plain cut MDF.

PREM-ECON 1 MEDIUM DUTY WORKBENCHES



1500 x 700 c/w lino worktop
PEW157B + D1 + C1 £501.02



1500 x 700 c/w MDF worktop
PEW157C £200.26



1500 x 700 c/w lino worktop
PEW157B + D1 £379.24



1500 x 700 c/w lino worktop
PEW157B + C1 £408.91

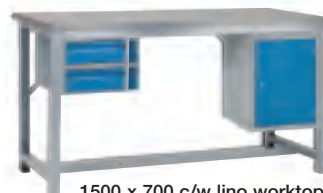

1500 x 700 c/w lino worktop
PEW157B + D2 + C1 £539.72

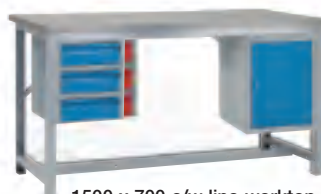

1500 x 700 c/w lino worktop
PEW157B + D3 + C1 £640.34



1500 x 700 c/w lino worktop
PEW157B + CD1 £531.32

DRAWERS & CABINETS

Description	Code	£
Single Drawer	D1	92.11
Double Drawer	D2	165.99
Triple Drawer	D3	231.43
Quad Drawer	D4	336.89
Cabinet Drawer	CD1	244.19
Cabinet	C1	121.78

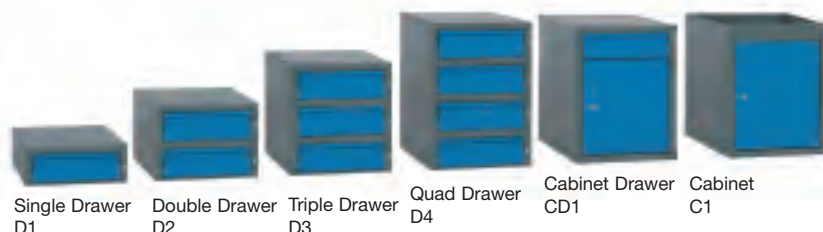

PREM-ECON 1 MOBILE MEDIUM DUTY WORKBENCHES

Take your workbench to the job with a mobile version of the prem-econ workbench system.

PREM-ECON 1 MEDIUM DUTY WORKBENCHES

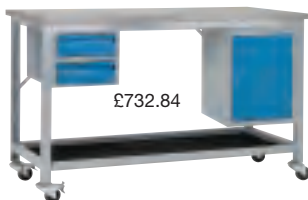
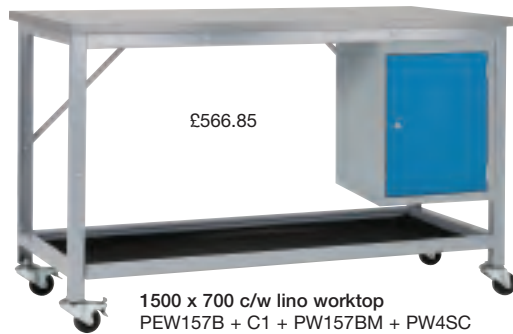

BASE SHELVES

L x W(mm)	Description	Code	£
1500 x 700	Base Shelf	PEW157BS	51.35
1500 x 700	Base Shelf/Mat	PEW157BM	91.87
2000 x 700	Base Shelf	PEW127BS	68.42
2000 x 700	Base Shelf/Mat	PEW127BM	114.74

CASTORS

Description	Code	£
Set of 4 swivel castors 2 x braked	PW4SC	66.07

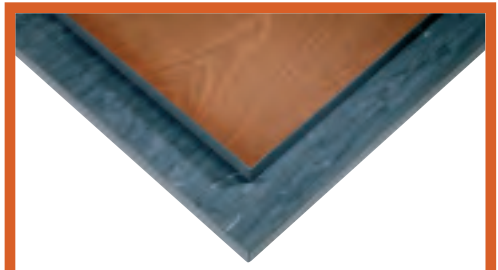

WORKTOPS

A = 30mm thick hardwood veneer top.

B = 30mm thick industrial marble grey lino.

C = 25mm thick plain cut MDF.

DRAWERS & CABINETS

Description	Code	£
Single Drawer	D1	92.11
Double Drawer	D2	165.99
Triple Drawer	D3	231.43
Quad Drawer	D4	336.89
Cabinet Drawer	CD1	244.19
Cabinet	C1	121.78



If not standard, please specify colour choice at time of order



PREM-ECON 2 HEAVY DUTY WORKBENCHES

Taking the Bedford Premier 2 heavy duty flat pack workbench frame and adding the standard Bedford underbench storage units makes for a quality yet economic workbench solution. Framework powder coated Mid grey RAL 7001 with a Blue RAL 5015 door and drawer.

WORKTOPS

- A = 30mm thick hardwood veneer top.
- B = 30mm thick industrial marble grey lino.
- C = 25mm thick plain cut MDF.

WORKBENCHES

L x W(mm)	Top	Code	£
1500 x 700	Veneer	PEW257A	255.49
1500 x 700	Lino	PEW257B	306.03
1500 x 700	MDF	PEW257C	225.41
2000 x 700	Veneer	PEW227A	300.97
2000 x 700	Lino	PEW227B	380.94
2000 x 700	MDF	PEW227C	261.67

ACCESSORIES

ACCESSORY POSTS

PEWAP1	1000mm high to accommodate combination back panel	£56.32
PEWAP2	1500mm high to accommodate back panel and upper shelf	£60.78
PEWAP3	2000mm high to accommodate back panel, upper shelf and light	£65.21

SERVICE DUCT

PEWSD15	1500mm long service duct with 2 x 2 13amp double sockets	£68.11
PEWSD18	2000mm long service duct with 2 x 2 13amp double sockets	£71.56

COMBINATION BACK PANELS 450MM HIGH

PEWCP15	1500mm long back panel 1/2 louvred 1/2 perforated	£78.14
PEWCP20	2000mm long back panel 1/2 louvred 1/2 perforated	£107.55

UPPER SHELVES

PEWUSS15	1500mm long steel upper shelf	£54.26
PEWUSS20	2000mm long steel upper shelf	£65.46

LIGHT BAR WITH 1200MM STRIP LIGHT*

PEWLU15	1500mm long supplied with diffuser	£96.10
PWLU20	2000mm long supplied with diffuser	£108.39

*All electrics are supplied unwired, for fitting by a suitably qualified electrician

PREM-ECON 1 MEDIUM DUTY WORKBENCHES

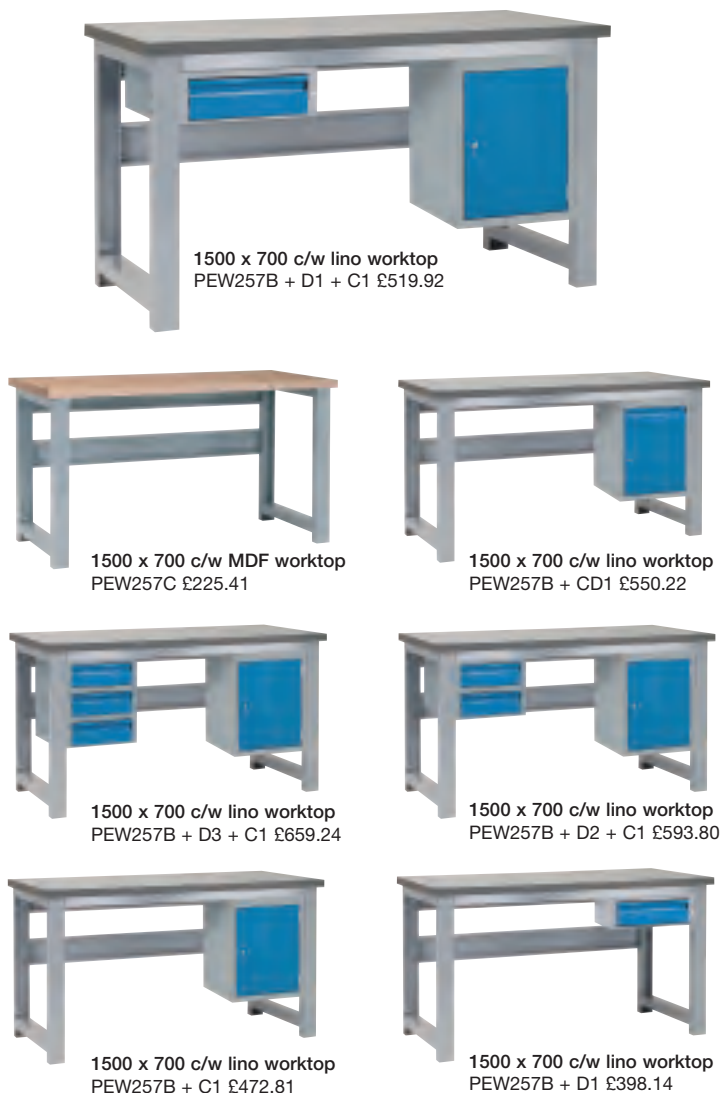

DRAWERS & CABINETS

Description	Code	£
Single Drawer	D1	92.11
Double Drawer	D2	165.99
Triple Drawer	D3	231.43
Quad Drawer	D4	336.89
Cabinet Drawer	CD1	244.19
Cabinet	C1	121.78

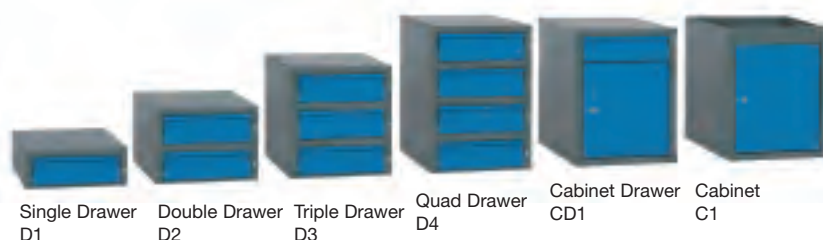

ESD WORKBENCH ACCESSORIES



Workstation Kits
see side panel for info & pricing



Configuration Kits
see side panel for info & pricing



EPA Super Kits
see side panel for info & pricing

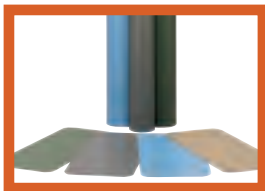

Bench Coverings
see side panel for info & pricing



Bench-Saver Mats
see side panel for info & pricing

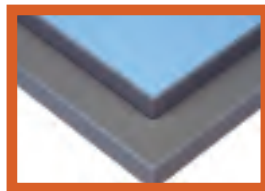

A/S Rubber Worktops
see side panel for info & pricing



ESD Laminate Worktops
see side panel for info & pricing



Mat Ground Cord (3m)
BED-CW-60358 P.O.A



Push & Clinch Snap Socket
BED-CW-800008 P.O.A



Universal Snap Kit
BED-CW-80014 P.O.A



Wrist Straps
see side panel for info & pricing



Leads
see side panel for info & pricing



Wrist Band
BED-WE-AY £6.56



Adaptor
BED-ADP4BP10 £5.95



Male Press Studs (Screw - pk10)
BED-PSM-10S £3.95



Male Press Studs (Punch - pk10)
BED-PSM-10 £2.95



Earth Bonding Point Box
BED-BLB-43 £18.95



Earth Bonding Plate (Press Stud)
BED-EBB-10 £12.95



Earth Bonding Plate (2BA Terminal)
BED-EFB-T £15.95



Earth Grounding Label
BED-GPL-3636 £1.95



Earth Bonding Label
BED-BPL-3636 £1.95

WORKSTATION KITS

L x W(mm)	Code	£
1200 x 600	BED-WSK1-1206	87.76
1500 x 600	BED-WSK1-1506	98.32
1800 x 600	BED-WSK1-1806	109.05

CONFIGURATION KITS

L x W(mm)	Code	£
300 x 200	BED-FCC-0302	30.91
400 x 300	BED-FCC-0403	50.18

EPA SUPER KITS

L x W(mm)	Code	£
1200 x 600	BED-ESK-1206	302.34
1500 x 600	BED-ESK-1506	319.37
1800 x 600	BED-ESK-1806	336.59

NEOSTAT C2 FLEXIBLE MATTING

L x W(mm)	Code	£
1200 x 600	BED-BMC2-1206	45.73
1500 x 600	BED-BMC2-1506	57.20
1800 x 600	BED-BMC2-1806	68.51

NEOSTAT C2 ROLLS

L x W(mm)	Code	£
10m x 1000	BED-BMC2-ROLL1000	581.73
10m x 1200	BED-BMC2-ROLL1200	696.17

BENCH SAVER MATS

L x W(mm)	Code	£
250 x 200	BED-BSC2-0202	8.94
700 x 300	BED-BSC2-0703	19.79

ESD WORKTOPS

L x W(mm)	Code	£
1200 x 600	BED-RTN-1206	P.O.A
1200 x 750	BED-RTN-1207	P.O.A
1200 x 900	BED-RTN-1209	P.O.A
1500 x 600	BED-RTN-1506	P.O.A
1500 x 750	BED-RTN-1507	P.O.A
1500 x 900	BED-RTN-1509	P.O.A
1800 x 600	BED-RTN-1806	P.O.A
1800 x 750	BED-RTN-1807	P.O.A
1800 x 900	BED-RTN-1809	P.O.A

please suffix order code for worktop option with:
G = Grey Rubber - B = Blue Rubber - L = Laminate

WRIST STRAP (WITH 4MM BANANA PLUG)

L (mm)	Code	£
N/A	BED-WEE-201041Y	17.77

WRIST STRAP (WITH 10MM PRESS STUD)

L (mm)	Code	£
N/A	BED-WEE-2010101Y	17.77

LEADS (WITH 4MM BANANA PLUG)

L (mm)	Code	£
N/A	BED-E-201041Y	14.98

LEADS (WITH 10MM PRESS STUD)

L (mm)	Code	£
N/A	BED-E-2010101Y	14.98

All prices are Ex. Works. Carriage is £15.00



INFINITE WORKBENCH SYSTEM 1000KG UDL

INFINITE SYSTEM

Start with a 2m or 3m starter workbench and simply use add-on workbenches and accessories as required.

STRENGTH & FLEXIBILITY

Framework is constructed from fabricated steel section with welded leg supports and bolt in multi-position cross rails, which can be assembled in a variety of combinations to suit individual applications. Steel work powder coated dark grey (RAL 7031).

BENCHES (25MM MDF WORKTOP)

All benches are 840mm high as standard.

L x W(mm)	Description	Code	£
2000 x 700	Starter	KDB2078A	345.18
2000 x 700	Starter & Base	KDB2078BSA	409.84
2000 x 1200	Starter	KDB2028A	440.70
2000 x 1200	Starter & Base	KDB2028BSA	537.51
2000 x 1400	Starter	KDB2048A	481.36
2000 x 1400	Starter & Base	KDB2048BSA	635.39
3000 x 700	Starter	KDB3078A	556.23
3000 x 700	Starter & Base	KDB3078BSA	636.46
3000 x 1200	Starter	KDB3028A	684.59
3000 x 1200	Starter & Base	KDB3028BSA	776.59
3000 x 1400	Starter	KDB3048A	778.72
3000 x 1400	Starter & Base	KDB3048BSA	988.38
2000 x 700	Add-On	KDA278A	295.24
2000 x 700	Add-On & Base	KDA278BSA	359.41
2000 x 1200	Add-On	KDA228A	372.26
2000 x 1200	Add-On & Base	KDA228BSA	467.81
2000 x 1400	Add-On	KDA248A	412.18
2000 x 1400	Add-On & Base	KDA248BSA	566.21

BENCHES (30MM VENEER WORKTOP)

All benches are 840mm high as standard.

L x W(mm)	Description	Code	£
2000 x 700	Starter	KDB2078B	419.31
2000 x 700	Starter & Base	KDB2078BSB	484.04
2000 x 1200	Starter	KDB2028B	501.68
2000 x 1200	Starter & Base	KDB2028BSB	598.50
2000 x 1400	Starter	KDB2048B	555.16
2000 x 1400	Starter & Base	KDB2048BSB	709.51
3000 x 700	Starter	KDB3078B	661.05
3000 x 700	Starter & Base	KDB3078BSB	741.16
3000 x 1200	Starter	KDB3028B	853.60
3000 x 1200	Starter & Base	KDB3028BSB	945.58
3000 x 1400	Starter	KDB3048B	996.94
3000 x 1400	Starter & Base	KDB3048BSB	1,206.59
2000 x 700	Add-On	KDA278B	369.39
2000 x 700	Add-On & Base	KDA278BSB	431.26
2000 x 1200	Add-On	KDA228B	433.72
2000 x 1200	Add-On & Base	KDA228BSB	530.02
2000 x 1400	Add-On	KDA248B	485.99
2000 x 1400	Add-On & Base	KDA248BSB	640.02

BENCHES (30MM LINO WORKTOP)

All benches are 840mm high as standard.

L x W(mm)	Description	Code	£
2000 x 700	Starter	KDB2078C	437.49
2000 x 700	Starter & Base	KDB2078BSC	502.22
2000 x 1200	Starter	KDB2028C	567.99
2000 x 1200	Starter & Base	KDB2028BSC	664.80
2000 x 1400	Starter	KDB2048C	630.01
2000 x 1400	Starter & Base	KDB2048BSC	785.00
3000 x 700	Starter	KDB3078C	678.17
3000 x 700	Starter & Base	KDB3078BSC	784.41
3000 x 1200	Starter	KDB3028C	894.96
3000 x 1200	Starter & Base	KDB3028BSC	1,036.87
3000 x 1400	Starter	KDB3048C	1,245.45
3000 x 1400	Starter & Base	KDB3048BSC	1,394.71
2000 x 700	Add-On	KDA278C	452.18
2000 x 700	Add-On & Base	KDA278BSC	499.55
2000 x 1200	Add-On	KDA228C	560.87
2000 x 1200	Add-On & Base	KDA228BSC	596.35
2000 x 1400	Add-On	KDA248C	560.63
2000 x 1400	Add-On & Base	KDA248BSC	714.90



2000 x 1400 Starter workbench with MDF worktop & upper shelf unit
Order code: KDB2048A + PICTURED ACCESSORIES
US\$235 2000mm Upper Shelf
£546.85

Certain benches within the range are designed to accommodate two or more persons working together. With this in mind the upper shelf unit is accessible from both sides.

CREATE A RUN

Using the starter & extension method you can mix and match depths.



INFINITE WORKBENCH SYSTEM 1000KG UDL

CONVENIENCE

Each bench is supplied in flat pack form, the larger units having sectional worktops for ease of handling. Available in 2 lengths, 3 depths, and 3 worktop options.

ECONOMIC

This system offers great economic advantages over standard workbench sizes e.g. the 3000 x 1200mm workbench (opposite) is the equivalent working area of x 4 1500 x 600mm workbenches.).



2000 x 700 Starter workbench with MDF worktop, MDF base shelf, cabinet, triple drawer & leg socket
Order code: KDB2078BSA +C1 +D3 +LS1
£763.05



3000 x 1200 Starter workbench with MDF worktop, MDF base shelf and combined cabinet & drawer unit
Order code: KDB3028BSA + CD1
£620.28



3000 x 1200 Starter workbench with MDF worktop and MDF base shelf
Order code: KDB3028BSA
£776.59



3000 x 1200 Starter workbench with MDF worktop
Order code: KDB3028A
£684.59



- HEAVY DUTY MODULAR DESIGN
- STARTER & ADD-ON BENCHES
- HEIGHT ADJUSTABLE FROM 840-940MM IN 25MM INCREMENTS
- EASY TO ADD ACCESSORIES

ACCESSORIES

Description	Code	£
Cupboard Unit	C1	121.78
Single Drawer	D1	92.11
Two Drawer	D2	165.99
Three Drawer	D3	231.43
Cupboard / Drawer	CD1	244.19
13 Amp Socket	LS1	22.08
2000mm Tool Rail	TR20	119.24
2000mm Light & Tool Rail	LTR20	218.61
2000mm Upper Shelf	USS235	128.28
3000mm Upper Shelf	USS335	218.39
2000mm Service Duct	SD20	151.00
3000mm Service Duct	SD30	199.05



WORKTOPS

- A = 30mm thick hardwood veneer top.
2mm veneer surface on 28mm composite core.
Edge banded in 2mm thick grey plastic
- B = 30mm thick industrial marble grey lino.
2mm vinyl surface on 28mm composite core.
Edge banded in 2mm thick grey plastic.
- C = 25mm thick plain cut MDF

All base shelves are 18mm thick plain cut MDF

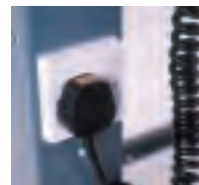

13 Amp Socket
Order code: LS1



Pre-punched to accommodate pipe work



MEDIUM DUTY SQUARE TUBE WORKBENCHES 45F

The Flexistation workbench system is ideal for light assembly work or a production run. These benches arrive on site built up with above the work surface accessories supplied loose. All workbenches are 840mm high as standard, other heights are available. Frames Mid Grey 7001, Doors/Drawers Blue 5015 as standard.



1800 x 750 Laminate worktop square tube workbench
Order code: 45F187C +

PICTURED ACCESSORIES

- D1 Single drawer
- C1 Cabinet
- SD18 Sloping fronted rear service duct unwired
- AP3 Accessory posts
- LP18 Louvre panel
- USS18 Upper shelf
- LU18 Light bar

SECURITY STORAGE

Lockable storage cabinets and drawers to encourage an efficient workstation and workplace.

ADJUSTABLE FEET

Adjustable feet available to correct uneven floors



ESD
Worktop options G



1800 x 750 c/w Laminate worktop
Square Tube Workbench with Single Drawer & Cabinet
45F187C + D1 + C1



1800 x 750 c/w Laminate worktop
Square Tube Workbench with Base Shelf & Drawer
45F187C + BS18 + D1



1800 x 750 c/w Laminate worktop
Square Tube Workbench with Base Shelf
45F187C + BS18

SIZES		ORDER CODE							
L(mm)	W(mm)	Basic Benches*	A £	B £	C £	D £	E £	F £	G £
1200	600	45F126*	346.18	390.06	264.97	323.70	308.31	241.17	345.96
1200	750	45F127*	387.52	421.95	302.08	335.99	326.99	250.90	372.83
1200	900	45F129*	366.76	437.01	323.74	357.16	345.75	260.80	404.06
1500	600	45F156*	378.31	450.94	303.17	341.31	392.38	258.28	373.97
1500	750	45F157*	391.05	474.28	319.08	373.84	402.49	268.24	455.92
1500	900	45F159*	396.85	457.78	351.86	392.98	403.93	278.07	466.33
1800	600	45F186*	392.43	457.78	312.38	351.11	346.06	271.70	448.21
1800	750	45F187*	403.16	470.36	316.56	368.47	400.37	283.57	466.46
1800	900	45F189*	408.72	487.82	355.72	403.07	394.17	293.17	483.12

*choose a worktop and add A, B, C, D, E, F, G

MD WORKTOPS

- A = 1.5mm Steel on composite core
- B = 1.5mm Stainless steel on composite core
- C = 18mm Laminate
- D = 18mm Lino
- E = 24mm Plywood
- F = 24mm MDF
- G = 18mm ESD Laminate



MEDIUM DUTY CANTILEVER WORKBENCHES 46M

The Maxistation workbench system is ideal for light assembly work or a production run. These benches are designed to optimise space under the work surface, especially when used by seated operators. All workbenches are 840mm high as standard, other heights are available. Frames Mid Grey RAL 7001, Doors/Drawers Blue RAL 5015 as standard.



1800 x 750 Laminate worktop square tube workbench
Order code: 45F187C +

PICTURED ACCESSORIES

- D1 Single drawer
- C1 Cabinet
- SD18 Sloping fronted rear service duct unwired
- AP3 Accessory posts
- LP18 Louvre panel
- USS18 Upper shelf
- LU18 Light bar

SECURITY STORAGE

Lockable storage cabinets and drawers to encourage an efficient workstation and workplace.

ADJUSTABLE FEET

Adjustable feet available to correct uneven floors



ESD

Worktop options G



1800 x 750 c/w Laminate worktop
Cantilever Workbench
46M187C + D1 + C1



1800 x 750 c/w Laminate worktop
Cantilever Workbench
46M187C



1800 x 750 c/w Laminate worktop
Cantilever Workbench
46M187C + D2 + C1

SIZES		ORDER CODE							
L(mm)	W(mm)	Basic Benches*	A £	B £	C £	D £	E £	F £	G £
1200	600	46M126*	377.11	421.18	306.23	360.17	341.93	279.45	353.08
1200	750	46M127*	388.24	451.32	342.54	376.59	359.80	288.44	371.09
1200	900	46M129*	396.79	466.02	364.72	397.29	377.73	297.36	407.20
1500	600	46M156*	407.84	479.40	343.61	381.80	422.32	295.13	376.67
1500	750	46M157*	420.02	492.09	359.84	413.60	432.01	305.02	453.82
1500	900	46M159*	425.57	501.73	391.25	432.33	434.40	314.42	467.94
1800	600	46M186*	431.60	485.95	352.61	391.38	378.04	308.32	451.04
1800	750	46M187*	421.36	498.29	356.70	408.35	429.99	319.66	468.50
1800	900	46M189*	431.60	514.68	394.89	442.19	424.57	328.82	484.44

*choose a worktop and add A, B, C, D, E, F, G, denoting which you require.

MD WORKTOPS

- A = 1.5mm Steel on composite core
- B = 1.5mm Stainless steel on composite core
- C = 18mm Laminate
- D = 18mm Lino
- E = 24mm Plywood
- F = 24mm MDF
- G = 18mm ESD Laminate



If not standard, please specify colour choice at time of order



WORKBENCH ACCESSORIES

A comprehensive range of accessories for storage above and below the work surface, lighting and power supply. Workbench accessories are factory fitted and not for retro-fit. Above worksurface accessories are supplied detached for transportation purposes.



BASE SHELVES

Code	Length(mm)	£
BS12	1200	56.69
BS15	1500	72.76
BS18	1800	78.81

Base shelves are 1.2mm thick steel sheet



DRAWERS - 25KG UDL

Code	Description	£
D1	Single drawer	92.11
D2	Double drawer	165.99
D3	Triple drawer	231.43
D4	Quad drawer	336.89
C1*	Cabinet:	121.78
	C1 Cabinet Size - External D450 x W450 x H600mm	
CD1*	Cabinet drawer:	244.19
	CD1 Cabinet Size - External D450 x W450 x H600mm Drawer Size - Internal D420 x W355 x H100mm	

*Includes shelf

CASTORS

Code	Description	£
C100	x 4 100mm	79.81



100MM RETAINING LIP THREE SIDES

Code	Description	£
SL12	Retaining lip	29.11
SL15	Retaining lip	32.91
SL18	Retaining lip	36.71



PRE WIRED SERVICE DUCT

Sloping fronted rear service duct wired

Code	Length(mm)	£
WD12	1200	339.60
WD15	1500	385.88
WD18	1800	441.42

Pre wired with RCB 2 x 2 sockets + cable.



ELECTRICS

Sloping fronted rear service duct unwired

Code	Length(mm)	£
SD12	1200	66.25
SD15	1500	69.65
SD18	1800	73.18

Supplied unwired, for fitting by a suitably qualified electrician.



ACCESSORY POSTS

Code	Height(mm)	£
AP1	1000	57.60
AP2	1500	62.16
AP3	2000	65.21

Adjustable and supplied in pairs.



LOUVRE PANELS†

Code	Length(mm)	£
LP12	1200	65.62
LP15	1500	79.91
LP18	1800	99.76



PERFORATED PANELS†

Code	Length(mm)	£
TP12	1200	65.62
TP15	1500	79.91
TP18	1800	99.76



UPPER SHELVES††

Code	Length(mm)	£
USS12*	1200	46.70
USS15*	1500	55.50
USS18*	1800	66.95

*Upper shelves are 2mm thick steel. Laminate & MDF also available.



LIGHT BARS†††

Code	Length(mm)	£
LU12	1200	96.44
LU15	1500	98.28
LU18	1800	100.62

Supplied unwired, for fitting by electrician.

LOUVRED CATEGORY 2 LIGHT BARS†††

Code	Length(mm)	£
CU12	1200	145.23
CU15	1500	146.81
CU18	1800	148.40

Supplied unwired, for fitting by electrician.



VICE PLATE

Code	Description	£
VP	Vice plate	13.29

VICES INC. VICE PLATE

BV75VP	75mm Engineers	52.90
BV15VP	150mm Engineers	98.90
BW7VP	7" wood	79.35
BW9VP	9" wood	104.65



PLASTIC BINS (Per Pack)

Code	L	W	D(mm)	£	QTY
BB2	165	100	75	46.69	20
BB3	240	150	125	50.37	10
BB4	355	220	125	65.21	10
BB5	355	200	175	78.54	10

Price per pack + £20.00 carriage

WORKBENCH OPTIONS

Medium & heavy duty workbenches are available in the following options, please add:

Code	Description	£
SDC	Sliding Door	474.39
FP	Flat Pack	46.28

†ACCESSORY POSTS REQUIRED

† AP1 Required
 †† AP2 Required
 ††† AP3 Required



Accessories page 31



If not standard, please specify colour choice at time of order

MEDIUM & HEAVY DUTY WORKBENCHES

A comprehensive range of fully welded angle iron construction workbenches with a variety of worktop options and accessories. All workbenches are 840mm high as standard, other heights available. Popular models - available in all sizes from 1200mm long x 600mm wide to 1800mm long x 900mm wide. All workbenches are 840mm high as standard, other heights available. Frames Mid Grey RAL 7001, Doors/Drawers Blue RAL 5015 as standard.

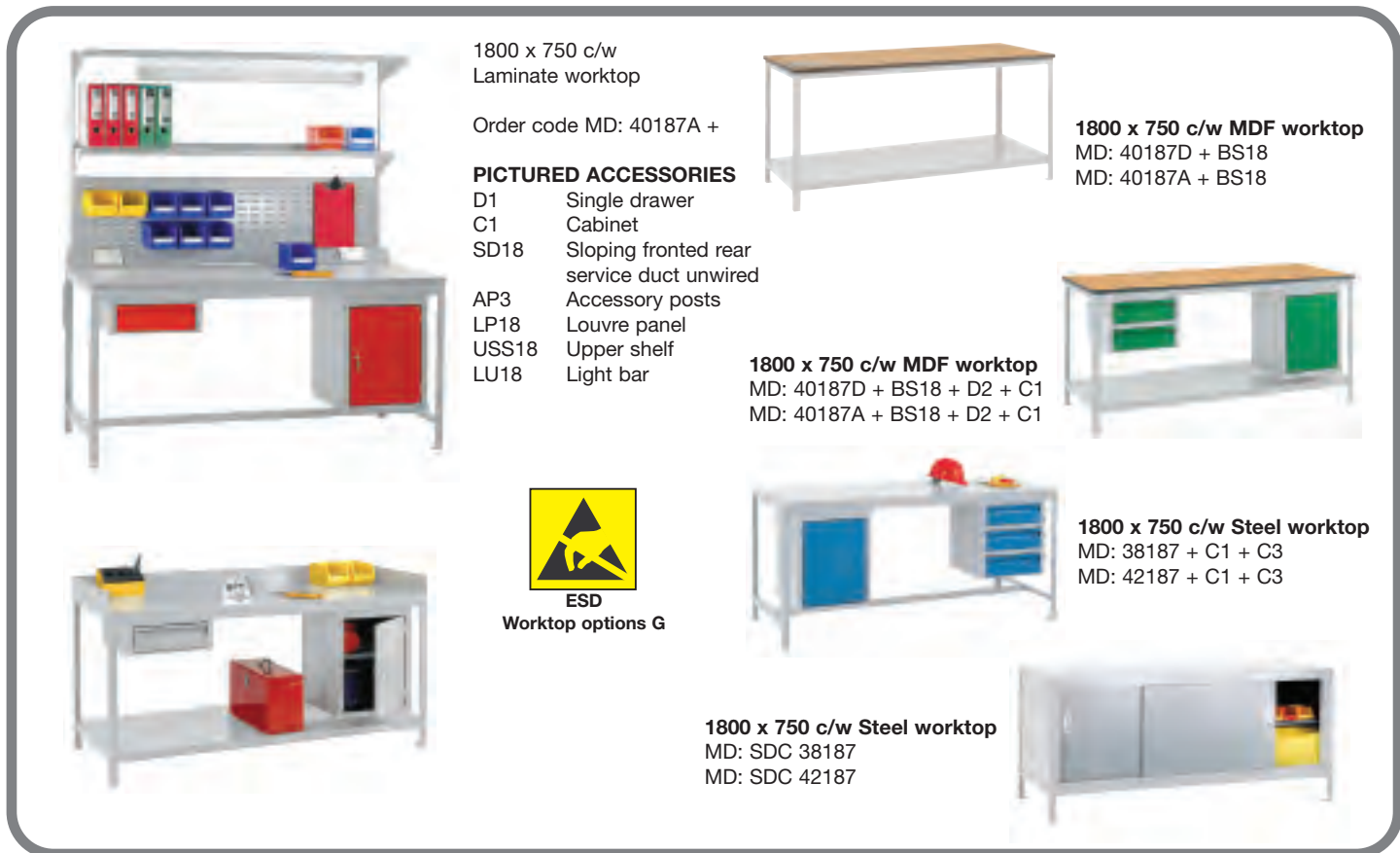

1800 x 750 c/w
Laminate worktop

Order code MD: 40187A +

PICTURED ACCESSORIES
 D1 Single drawer
 C1 Cabinet
 SD18 Sloping fronted rear service duct unwired
 AP3 Accessory posts
 LP18 Louvre panel
 USS18 Upper shelf
 LU18 Light bar

1800 x 750 c/w MDF worktop
MD: 40187D + BS18
MD: 40187A + BS18

1800 x 750 c/w MDF worktop
MD: 40187D + BS18 + D2 + C1
MD: 40187A + BS18 + D2 + C1

1800 x 750 c/w Steel worktop
MD: 38187 + C1 + C3
MD: 42187 + C1 + C3

1800 x 750 c/w Steel worktop
MD: SDC 38187
MD: SDC 42187

ESD
Worktop options G

MEDIUM DUTY WORKBENCHES (500KG UDL)

Welded construction from 40 x 40 x 4mm angle iron with 2 pairs of leg supports with single bottom mounted cross rail.

SIZES		ORDER CODES		ORDER CODES							
L(mm)	W(mm)	2mm Steel Top	£	Wood Top*	A £	B £	C £	D £	E £	F £	G £
1200	600	38126	242.79	40126*	377.11	421.18	282.02	311.22	322.68	280.46	331.65
1200	750	38127	245.98	40127*	388.24	451.32	288.12	312.88	335.71	290.03	352.67
1200	900	38129	256.45	40129*	396.79	466.02	314.95	345.88	358.72	299.60	388.88
1500	600	38156	252.89	40156*	407.84	479.40	292.53	331.25	355.65	292.84	357.75
1500	750	38157	253.49	40157*	420.02	492.09	310.96	365.87	424.07	302.73	442.88
1500	900	38159	268.50	40159*	425.57	501.73	349.96	391.31	427.83	315.09	458.91
1800	600	38186	268.32	40186*	431.60	485.95	309.28	348.68	369.51	303.96	462.05
1800	750	38187	278.60	40187*	421.36	498.29	315.45	368.80	431.48	316.05	462.05
1800	900	38189	288.09	40189*	431.60	514.68	354.92	403.07	435.27	328.11	477.50

MD WORKTOPS

- A = 1.5mm Steel on composite core
- B = 1.5mm Stainless steel on composite core
- C = 18mm Laminate
- D = 18mm Lino
- E = 24mm Plywood
- F = 24mm MDF
- G = 18mm ESD Laminate

HEAVY DUTY WORKBENCHES (1000KG UDL)

Welded construction from 50 x 50 x 5mm angle iron with 2 pairs of leg supports with single bottom mounted cross rail.

SIZES		ORDER CODES		ORDER CODES				
L(mm)	W(mm)	3mm Steel Top	£	Wood Top*	A £	B £	C £	D £
1200	600	42126	275.03	44126*	296.96	336.53	347.87	P.O.A
1200	750	42127	288.08	44127*	307.98	351.83	373.81	P.O.A
1200	900	42129	301.13	44129*	319.23	376.72	427.02	P.O.A
1500	600	42156	292.74	44156*	310.91	371.30	428.46	P.O.A
1500	750	42157	308.13	44157*	323.22	441.08	479.76	P.O.A
1500	900	42159	323.55	44159*	334.53	447.66	446.95	P.O.A
1800	600	42186	307.73	44186*	323.27	386.50	428.47	P.O.A
1800	750	42187	325.38	44187*	333.71	449.19	489.17	P.O.A
1800	900	42189	343.04	44189*	351.33	456.72	491.22	P.O.A

HD WORKTOPS

- 3mm Steel
- A = 24mm MDF
- B = 24mm Plywood
- C = 38mm Plywood
- D = 30mm Beech Hardwood



If not standard, please specify colour choice at time of order



EXTRA HEAVY DUTY LARGE WORKBENCHES

Ideal for an engineering environment. These benches are of fully welded rugged construction, designed to take the everyday knocks of the industrial workplace. All workbenches are 840mm high as standard, other heights available. Frames Grey RAL 7031, Doors/Drawers Blue RAL 5015 as standard.



MODEL 44C2 (WOOD TOP)

1800 x 750 with 24mm MDF top, right hand cabinet and left hand drawer

Order code: 44287A +

PICTURED ACCESSORIES

D1 Single drawer
C1 Cabinet

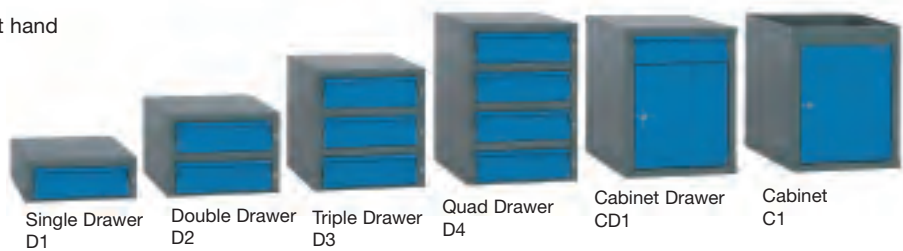

EXTRA HEAVY DUTY (HD = 1500KG UDL)

Welded construction from 50x50x5mm angle iron leg supports. 3 pairs supplied.

SIZES		ORDER CODES		ORDER CODES				
L(mm)	W(mm)	3mm Steel Top	£	Wood Top*	A £	B £	C £	D £
1800	750	42287	485.19	44287*	434.12	547.33	683.17	P.O.A
1800	900	42289	505.57	44289*	450.12	551.18	690.45	P.O.A
2000	750	42227	497.73	44227*	456.12	570.00	745.87	P.O.A
2000	900	42229	519.31	44229*	463.06	577.37	753.24	P.O.A
2400	750	42247	521.70	44247*	476.70	613.44	754.26	P.O.A
2400	900	42249	546.82	44249*	483.74	620.99	761.80	P.O.A
2400	1200	42242	597.03	44242*	497.77	636.10	776.93	P.O.A
3000	750	42237	557.09	44237*	P.O.A	P.O.A	P.O.A	P.O.A
3000	900	42239	588.65	44239*	P.O.A	P.O.A	P.O.A	P.O.A
3500	750	42257	588.65	44257*	P.O.A	P.O.A	P.O.A	P.O.A
3500	900	42259	622.29	44259*	P.O.A	P.O.A	P.O.A	P.O.A

*When choosing a wooden top add A, B, C, or D to order code, denoting which finish you require.

HD WORKTOPS

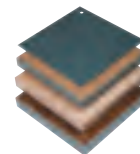

- 3mm Steel
- A = 24mm MDF
- B = 24mm Plywood
- C = 38mm Plywood
- D = 30mm Beech Hardwood



HEIGHT ADJUSTABLE ERGONOMIC WORKBENCHES 48HA

Ideally suited to most work environments - Education, Electronics, Aerospace, Health, Light Assembly & Industrial research Laboratories etc. Frames Light Grey RAL 7035, Doors/Drawers Grey RAL 7031 as standard.



300KG UDL
Satisfy requirements of Disability Discrimination Act 1995

Removable crank handle

'Put it straight to work' - supplied in built up form

Cantilever leg design for ease of movement

Sit or Stand

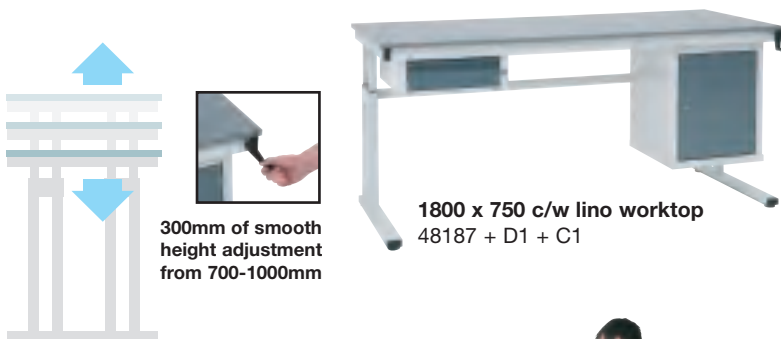

300mm of smooth height adjustment from 700-1000mm

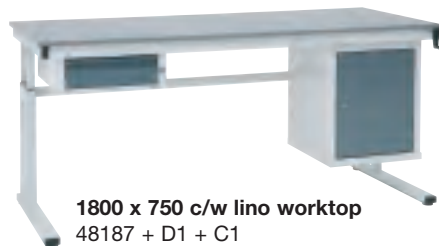

1800 x 750 c/w lino worktop
48187 + D1 + C1

WORK STANDING



WORK SEATED



Single Drawer D1

Double Drawer D2

Triple Drawer D3

Quad Drawer D4

Cabinet Drawer CD1

Cabinet C1

WORKBENCHES

L x W(mm)	Top	Code	£
1500 x 750	18mm Laminate	48157C	659.11
1800 x 750	18mm Laminate	48187C	659.11
1500 x 750	18mm Lino	48157D	672.50
1800 x 750	18mm Lino	48187D	672.50
1500 x 750	24mm MDF	48157F	587.77
1800 x 750	24mm MDF	48187F	597.77
1500 x 750	18mm ESD Laminate	48157G	745.52
1800 x 750	18mm ESD Laminate	48187G	760.20

DRAWERS & CABINETS

Description	Code	£
Single Drawer	D1	92.11
Double Drawer	D2	165.99
Triple Drawer	D3	231.43
Quad Drawer	D4	336.89
Cabinet	C1	121.78
Cabinet Drawer	CD1	244.19

ACCESSORY POSTS

Description	Code	£
1000mm High	HAP1	57.60
1500mm High	HAP2	62.16
2000mm High	HAP3	65.71

LOUVRE PANELS

Description	Code	£
1500mm Length	LP15	79.91
1800mm Length	LP18	99.76

STEEL UPPER SHELVES

Description	Code	£
1500mm Steel Upper Shelf	USS15	55.50
1800mm Steel Upper Shelf	USS18	66.95

ELECTRICS (unwired)

Description	Code	£
1500mm Light Bar	LU15	98.28
1800mm Light Bar	LU18	100.62
1500mm Cat2 Light Bar	CU15	146.81
1800mm Cat2 Light Bar	CU18	148.40
1500mm Service Duct	SD15	69.65
1800mm Service Duct	SD18	73.18



TIMBER WORKBENCHES

A robust and durable workbench constructed to a very high standard. A large choice of sizes, worktop options and accessories available make it ideal for a range of applications. Protective hardwood feet supplied as standard on all benches. Build your own workbench by using the basic flat-topped bench, with the choice of three work surface options and any combination of the accessories below. Finished with 2 coats of clear lacquer.

WORKBENCHES

L x D(mm)	Top	Code	£
1200 x 750	Plywood	BET001	351.67
1200 x 750	Lino	BET067	409.18
1200 x 750	Hardwood	BET076	477.98
1200 x 900	Plywood	BET002	386.84
1200 x 900	Lino	BET068	450.01
1200 x 900	Hardwood	BET077	525.48
1200 x 1200	Plywood	BET003	425.50
1200 x 1200	Lino	BET069	495.11
1200 x 1200	Hardwood	BET078	578.35
1500 x 750	Plywood	BET004	387.07
1500 x 750	Lino	BET070	450.10
1500 x 750	Hardwood	BET079	525.49
1500 x 900	Plywood	BET005	425.50
1500 x 900	Lino	BET071	495.11
1500 x 900	Hardwood	BET080	578.35
1500 x 1200	Plywood	BET006	468.07
1500 x 1200	Lino	BET072	544.63
1500 x 1200	Hardwood	BET081	636.18
1800 x 750	Plywood	BET007	425.50
1800 x 750	Lino	BET073	495.11
1800 x 750	Hardwood	BET082	578.35
1800 x 900	Plywood	BET008	468.08
1800 x 900	Lino	BET074	544.63
1800 x 900	Hardwood	BET083	636.18
1800 x 1200	Plywood	BET009	514.87
1800 x 1200	Lino	BET075	599.07
1800 x 1200	Hardwood	BET084	699.79

BOTTOM SHELF (Factory fitted)

L x D(mm)	Code	£
1200 x 750	BET023	48.99
1200 x 900	BET024	51.43
1200 x 1200	BET025	54.02
1500 x 750	BET026	59.36
1500 x 900	BET027	61.35
1500 x 1200	BET028	63.33
1800 x 750	BET029	65.31
1800 x 900	BET030	67.03
1800 x 1200	BET031	69.28

ACCESSORIES (Factory fitted)

Description	Code	£
Cupboard Unit	BET010	167.56
Drawer Unit	BET011	198.14
Security Cupboard	BET012	139.10
Tool Rack	BET013	19.88
Saw Rack	BET014	11.26
Plane Stop	BET015	30.76
Record Vice	BET016	275.09
Back Lip L1200mm	BET017	27.82
Back Lip L1500mm	BET018	36.30
Back Lip L1800mm	BET019	42.90
Back Panel L1200mm	BET020	45.25
Back Panel L1500mm	BET021	52.26
Back Panel L1800mm	BET022	63.84



1800 x 750 c/w
hardwood worktop £
Order code: **BET082 +** **578.35**
BET010 Cupboard **167.56**
BET011 Drawer **198.14**
BET029 Bottom Shelf **65.31**
BET016 Record Vice **275.09**
BET022 Back Panel **63.84**
BET013 Tool Rack **19.88**
BET013 Tool Rack **19.88**

All benches are 850mm high as standard

Choice of worktops to suit all applications

Adjustable foot to allow for uneven floors

A robust and durable softwood framed timber workbench constructed to a very high standard that is practical and attractive

Ideal for a range of applications in industry, commerce, building trade and education

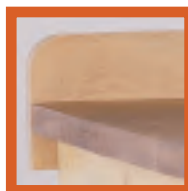

Back Lip
18mm Plywood

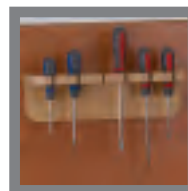

Tool Rack
6 Slot - Back Panel
or Side Mounted



Back Panel
305mm High

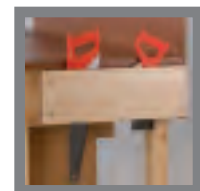

Saw Rack
Left or Right Mounted

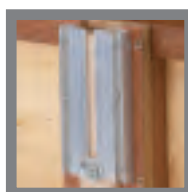

Plane Stop
Prevents work in
progress moving

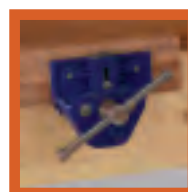

Record Vice
175mm Jaws
(Factory fitted only)



Security Cupboard
Left or Right Positioning.
Lockable



Cupboard/Drawer
Unit

TIMBER WORKBENCHES

QUALITY

High quality timber workbenches constructed in medium, heavy & extra heavy duty form, from selected softwood and kiln dried hardwood with timber or steel framework.

STANDARD OR BESPOKE

All 3 timber workbenches are available in various standard sizes. Custom building to own requirements is also available.

FINISH

Finished in a clear lacquer, other finishes available on request. Any steel work finished in grey RAL 7031 as standard.

MAINTENANCE WORKBENCH

All hardwood with laminate faced worktop and retaining edge. Fitted with MDF storage cabinet.
Order code: TM879
£1,485.00



SOFTWOOD ASSEMBLY WORKBENCH

L x W x H(mm)	Code	Leg Supports	£
1800 x 760 x 900	TA879	2	805.28
3050 x 760 x 900	TA379	3	870.75
3650 x 760 x 900	TA679	4	1,040.18

MAINTENANCE WORKBENCH

L x W x H(mm)	Code	£
1800 x 760 x 900	TM879	1,485.00
2400 x 760 x 900	TM279	1,606.50
3050 x 760 x 900	TM379	1,803.60

FITTERS WORKBENCH

L x W x H(mm)	Code	£
1800 x 760 x 900	TF879	1,370.93
2400 x 760 x 900	TF279	1,760.40
3050 x 760 x 900	TF379	1,846.80

ALL SOFTWOOD ASSEMBLY WORKBENCH



Constructed with a 40mm (nominal) tongue and grooved worktop. Softwood bracing and cross rails on 75mm thick square legs. Supplied fully built up with a clear lacquer finish. Can be fitted with optional drawers & cabinets.

Order code: TA379 £870.75

HEAVY DUTY FITTERS WORKBENCH

Solid hardwood top on 50mm steel tubular framework with MDF storage cabinets. Optional extra - steel angle worktop, protective edge and service ducts.

Order code: TF379 £1,846.80

With optional extras £1,995.00



ERGONOMIC INDUSTRIAL SEATING

Comprehensive range of industrial chairs suitable for most working environments.



UPHOLSTERED OPERATOR

Order code: UB2
Regular low lift
430-570 gas height
adjustment
with 5 star
glide base.

Shown in
hardwearing
charcoal fabric

£73.42



POLYURETHANE OPERATOR

Order code: PB2
Regular low lift
430-570
gas height
adjustment
with 5 star
glide base.

£110.73



ESD OPERATOR

Order code: AB2
Regular low lift
430-570
gas height
adjustment
with 5 star
glide base.

Shown in
hardwearing
charcoal fabric
Compliant with
UK & EU regulations

£99.33



INDUSTRIAL CHAIRS & STOOL

Order code: IB2
High lift 550-800 gas
height adjustment
with adjustable
high foot
ring and glides.

£123.66



Order code: UB2C
Low lift with castors
450-590 gas height
adjustment with
5 starcastor base.

Shown in
hardwearing
black vinyl

£81.52



Order code: PB2C
Low lift with castors
450-590 gas height
adjustment with
5 star castor base.

£112.80



Order code: AB2C
Low lift with castors
450-590 gas
height adjustment
with 5 star
castor base.

Shown in
hardwearing
charcoal fabric

£129.87



Order code: IB2C
Low lift with castors
470-600 gas height
adjustment with
5 star castor base.

**High Comfort
for continuous
duties**

£139.81



Order code: UB3
High lift 550-800 gas
height adjustment
with 200mm high
foot ring and glides.

Shown in
hardwearing
blue fabric

£91.78



Order code: PB3
High lift 550-800
gas height adjustment
with 200mm high
foot ring and glides.

£119.52



Order code: AB3
High lift 550-800 gas
height adjustment
with 200mm high
foot ring and glides.

Shown in
hardwearing
blue fabric

£113.31



Order code: IBS
Low lift stool 550-800
gas height adjustment
with 5 star
glide base.

£95.20

UPHOLSTERED OPERATOR
Optional Arms £30.00

Fabric Colour Options
Charcoal, Red, Blue

Vinyl Colour Options
Black, Red, Blue

POLYURETHANE OPERATOR
Optional Arms £30.00

Colour
Black Polyurethane

ESD OPERATOR
Optional Arms £30.00

ESD Colour Fabric Options
Charcoal, Blue, Black Vinyl

INDUSTRIAL CHAIRS & STOOL
Optional Arms £30.00

OPTIONS & ACCESSORIES



PREMIER TROLLEYS

Based on the popular Premier storage units mounted on 4 x 100mm diameter blue polyurethane tyred castors (2 braked). Welded and riveted construction from 0.9mm thick sheet steel. All cabinets are lockable and contain 1 adjustable shelf. All drawers are mounted on precision ball bearing telescopic slides offering a 40Kg (UDL) capacity. Overall size: 1200mm Length x 600mm Width x 835mm (approx.) High. Mid grey RAL 7001 carcase with Red RAL 3020 door/drawer colour.



PT1A 25mm Plywood £591.81
PT1B 25mm Plain MDF 556.78

PT2A 25mm Plywood £676.75
PT2B 25mm Plain MDF £656.72

TROLLEYS

L x W x H(mm)	Code	Top	£
1200 x 600 x 835	PT1A	25mm Plywood	591.81
1200 x 600 x 835	PT1B	25mm Plain MDF	556.78
1200 x 600 x 835	PT2A	25mm Plywood	676.75
1200 x 600 x 835	PT2B	25mm Plain MDF	656.72
1200 x 600 x 835	PT3A	25mm Plywood	990.13
1200 x 600 x 835	PT3B	25mm Plain MDF	978.70
1200 x 600 x 835	PT4A	25mm Plywood	687.09
1200 x 600 x 835	PT4B	25mm Plain MDF	637.87
1200 x 600 x 835	PT5A	25mm Plywood	840.11
1200 x 600 x 835	PT5B	25mm Plain MDF	805.80
1200 x 600 x 835	PT6A	25mm Plywood	888.98
1200 x 600 x 835	PT6B	25mm Plain MDF	854.72



PT3A 25mm Plywood £990.13
PT3B 25mm Plain MDF £978.70



PT4A 25mm Plywood £687.09
PT4B 25mm Plain MDF £637.87



PT5A 25mm Plywood £840.11
PT5B 25mm Plain MDF £805.80



PT6A 25mm Plywood £888.98
PT6B 25mm Plain MDF £854.72



If not standard, please specify colour choice at time of order



GENERAL PURPOSE & MAINTENANCE TROLLEYS

This extensive range of general purpose trolleys is of fully welded construction, with tubular end frames. Overall 1060mm long x 460mm wide x 950mm high including 100mm diameter nylon swivel castors. The work surface, base and intermediate shelves can be supplied with edges lipped down if required (to be specified at time of ordering). Blue RAL 5015.

TROLLEYS

L x W x H(mm)	Code	£
1060 x 460 x 950	GP1	159.25
1060 x 460 x 950	GP2	381.16
1060 x 460 x 950	GP3	180.03
1060 x 460 x 950	GP4	376.08
1060 x 460 x 950	GP5	503.94
1060 x 460 x 950	MT3	292.20
1060 x 460 x 950	MT3D	391.32

AS STANDARD

All trolleys are supplied with all swivel 100mm nylon castors offering a carrying capacity of 200Kg (UDL). Rubber tyred castors offer a capacity of 150Kg (UDL).

SHELVES

Trolley shelves are supplied with 30mm retaining lip to 4 sides as standard except GP5 and MT3 which have 30mm base lipped down.

COLOUR OPTIONS

Supplied in blue as standard with drawers and cabinet doors in light grey, other options available.

OPTIONS & ACCESSORIES (factory fitted)

Description	Code	£
Braked castors (pair)	BC	25.34
Rubber Mat	RM	22.03
Plastic tray	PT	33.44



Fully welded all steel 2 tier trolley
Order code: GP1 £159.25



Fully welded all steel 2 tier trolley with double drawer
Order code: GP2 £381.16

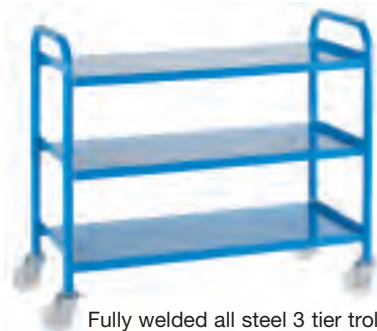

Fully welded all steel 3 tier trolley
Order code: GP3 £180.03



Fully welded all steel 2 tier trolley with double cabinet
Order code: GP4 £376.08



Fully welded 2 tier all steel trolley with triple drawer and cabinet
Order code: GP5 £503.94



Fully welded all steel 2 tier trolley with cabinet, drawer and intermediate shelf with optional rubber tyre castors*
Order code: MT3D + RT Tyred £391.32



Plastic Tray

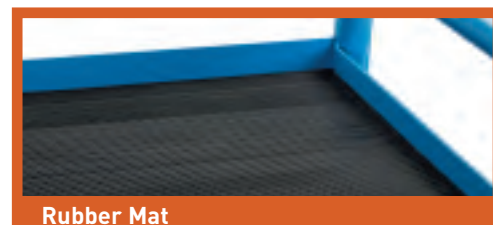

Rubber Mat



Rubber Tyre Castors (150kg UDL)



If not standard, please specify colour choice at time of order



MEDICAL TROLLEYS

Welded construction with tubular end frames. All medical trolleys are supplied with all swivel 100mm rubber tyred castors offering a UDL capacity of 150KG. Trolley shelves are supplied with 30mm retaining lip to all 4 sides. Powder coated white RAL 9003 and supplied with appropriate warning label.



GP4FA
£386.08

TROLLEYS

L x W x H(mm)	Code	Description	£
460 x 460 x 950	HP1FA	Two Tier	152.53
460 x 460 x 950	HP3FA	Three Tier	170.03
1060 x 460 x 950	GP1FA	Two Tier	159.25
1060 x 460 x 950	GP3FA	Three Tier	180.03
1060 x 460 x 950	GP4FA	Full Area Cupboard	386.08



GP3FA
£180.03



GP1FA
£159.25



HP1FA
£152.53



HP3FA
£170.03

SEE FIRST AID
STORAGE CABINETS
PAGE 17



STORAGE CABINETS





MEDIUM DUTY CABINETS: 88 SERIES

Of welded construction in 0.9mm steel sheet with reinforced doors secured by 3 way chrome lever locking handle. The units are supplied with adjustable internal shelves. Shelf capacity 75kg finished Mid Grey RAL 7001 with doors Blue RAL 5015.

CABINETS

H x W x D(mm)	Code	Shelves	Door	£
712 x 355 x 305	88W733	1	1	139.50
610 x 459 x 459	88W644	1	1	128.53
915 x 459 x 459	88W944	1	1	158.72
1830 x 459 x 459	88W844	3	1	254.63
610 x 610 x 305	88W663	1	2	203.07
712 x 915 x 305	88W793	1	2	209.17
712 x 915 x 459	88W794	1	2	212.90
915 x 915 x 459	88W994	1	2	216.89
1220 x 915 x 459	88W294	2	2	309.74
1525 x 915 x 459	88W594	3	2	332.94
1830 x 915 x 459	88W894	3	2	325.59
1830 x 915 x 459	88W894R	3	2	384.32
1830 x 915 x 459	88W894L	2	2	367.77
1830 x 915 x 459	88W894S	1	2	322.40
1830 x 1220 x 459	88W824	3	2	435.51

88W663 & 88W793 can be used as a wall mounted cabinet

EXTRA SHELVES

W x D(mm)	Code	£
355 x 305	88ES33W	18.75
459 x 459	88ES44W	19.85
610 x 305	88ES63W	19.85
915 x 459	88ES94W	24.95
1220 x 459	88ES24W	28.95

If ordered separately from a cabinet please add £15.00 carriage

SUPPORT STANDS (450MM HIGH)

H x W x D(mm)	Code	Suitable for	£
450 x 459 x 459	88WFS2	88W644, 944	63.52
450 x 915 x 459	88WFS3	88W794, 994, 294	67.46

CASTOR SET (Factory Fitted)

Set of 4x rubber tyred castors fitted.
2x fixed & 2x swivel braked.
Not an option on 1830 cabinets

Diameter(mm)	Code	£
125	C125	67.86



PLASTIC BINS (Per Pack)

Code	L	W	D(mm)	£	QTY
BB2	165	100	75	46.69	20
BB3	240	150	125	50.37	10
BB4	355	220	125	65.21	10
BB5	355	200	175	78.54	10

Price per pack + £20.00 carriage

- WELDED CONSTRUCTION
- ADJUSTABLE SHELVES
- 3 WAY CHROME LEVER LOCKING HANDLE
- REINFORCED DOORS

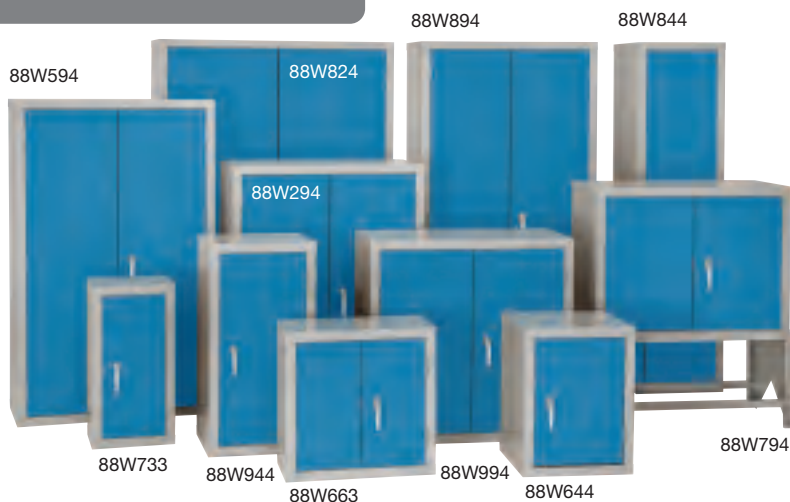

88W894R



88W894L



88W894S



88W894

MEDIUM DUTY

Everyday cabinets for the work environment.



If not standard, please specify colour choice at time of order



PREMIER BDU DESK UNITS: 88 SERIES

Welded and riveted construction from 0.9mm thick sheet steel. With 3 way locking chrome handle. Contains 1 x 75Kg (UDL) adjustable shelf. 25Kg capacity 3/4 extension lockable pull out drawers. Mid grey (RAL 7001) carcass with choice of door/drawer colour.

DESK UNITS

H x W x D(mm)	Code	Shelves	£
1205/1105 x 915 x 459	88BDU1	1	337.44
1205/1105 x 915 x 459	88BDU2	1	359.44



888BDU2



888BDU1

BASE CABINET
external measurements
915mm High
915mm Wide
459mm Depth



888BDU2



888BDU1



BEURO MODULAR CABINETS & DRAWERS: 88 SERIES

A versatile modular system that can be supplied as single items or as a full system. All cabinets have reinforced doors and adjustable shelves (capacity 75 kg per shelf UDL). Drawers have a capacity of 25 kg (UDL), have an internal height of 100mm and extend 3/4. Standard finish is Mid Grey RAL 70001 with choice of coloured doors or drawers in Black RAL 9005 or Blue RAL 5015.

CABINET - No.1

H900 x W500 x D500(mm)

Description	Code	£
1 door 2 shelves	88955A	153.03
1 door 1 deep drawer 1 shelf	88955B	242.41
1 door 2 drawers 1 shelf	88955C	330.55
Bank of 8 drawers non locking	88955D	376.48
Bank of 8 drawers central locking	88955E	415.34
500mm wide shelf*	88ES5	22.28
1000mm wide shelf*	88ES1	25.98

*If ordered separately from a cabinet please add £15.00 carriage

CABINET - No.2

H900 x W1000 x D500(mm)

Description	Code	£
2 doors 2 shelves	88915B	223.59
2 sliding doors 2 shelves	88915C	299.51
Bank of 8 drawers non locking	88915D	517.01
Bank of 8 drawers central locking	88915E	564.32

*If ordered separately from a cabinet please add £15.00 carriage

CABINET - No.3

H1200 x W1000 x D500(mm)

Description	Code	£
2 doors 2 shelves	88215A	302.44
2 sliding doors 2 shelves	88215C	414.07

*If ordered separately from a cabinet please add £15.00 carriage

CABINET - No.4

H1800 x W1000 x D500(mm)

Description	Code	£
2 doors 3 shelves	88815A	402.78
2 door louvred panel	88815B	441.96
2 sliding doors 3 shelves	88815C	430.94
2 doors, 1/2 louvred, 2 drawers	88815D	736.98
2 doors, 1/2 louvred, 6 drawers perforated doors*	88815E	841.48

Also available

6 drawer unit 712 x 900 x 450	88794D	435.81
-------------------------------	--------	--------



PLASTIC BINS (Per Pack)

Code	L	W	D(mm)	£	QTY
BB2	165	100	75	46.69	20
BB3	240	150	125	50.37	10
BB4	355	220	125	65.21	10
BB5	355	200	175	78.54	10

Price per pack + £20.00 carriage



CONSTRUCTION

Welded construction from 0.9mm thick sheet steel

MODULAR SYSTEM

A flexible solution to suit your workspace

Metric range of cabinets and drawer units.



If not standard, please specify colour choice at time of order



MESH DOOR CABINETS: 88 SERIES

Visibility of controlled stock without compromising security. Suitable for most working environments to store PPE, Tools, Manual & Computer peripherals etc. Standard finish is Mid Grey RAL 7001 with Blue RAL 5015 doors.

SEEN, SAFE & SECURE

Welded construction from 0.9mm thick steel with reinforced mesh panel door(s) for visibility and ventilation.



88MD894

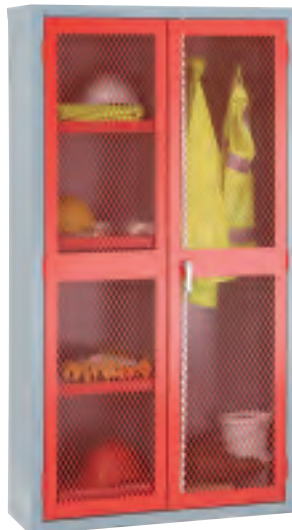

88MD894R



88MD844



88MD894L



88MD994



88MD944

CABINETS

H x W x D(mm)	Code	£
1830 x 915 x 459	88MD894L	424.38
1/2 louvred 2 shelves		
1830 x 915 x 459	88MD894R	411.96
Centre divider hanging rail & 3 shelves		
1830 x 915 x 459	88MD894	375.80
3 shelves		
1830 x 459 x 459	88MD844	311.72
3 shelves		
915 x 915 x 459	88MD994	265.33
1 shelf		
915 x 459 x 459	88MD944	175.09
1 shelf		

EXTRA SHELVES

W x D(mm)	Code	£
459 x 459	88ES44	22.28
915 x 459	88ES94	15.98

If ordered separately from a cabinet please add £15.00 carriage

ACCESSORIES (factory fitted)

Description	£
915mm high mesh side panels	46.00
1830mm high mesh side panels	69.00
459mm wide sloping top	52.00
915mm wide sloping top	67.00
459mm wide raised leg supports	41.00
915mm wide raised leg supports	49.00



FEATURES

The 1830mm high x 915mm width x 459mm depth models have a choice of internal accessories including: -
 3 adjustable shelves
 2 adjustable shelves & half louvred
 3 half adjustable shelves, hanging rail & centre divider
 Mid grey RAL 7001 carcass with door colour Blue RAL 5015



SLIDING MESH DOOR CABINETS: 84 SERIES

Visibility of controlled stock, for use in industrial and commercial applications. Keeps aisle space clear. Welded construction from 0.9mm thick steel. Maximum view mesh doors with 75Kg capacity (UDL) adjustable shelves. Mid Grey RAL 7001 carcass with Blue RAL 5015 doors as standard.

CABINETS

H x W x D(mm)	Code	Shelves	£
1830 x 915 x 460	84MD894	3	537.85
1830 x 1220 x 460	84MD824	3	580.91
1020 x 1220 x 460	84MD024	2	461.26
1020 x 1830 x 460	84MD084	2	619.88

EXTRA SHELVES (factory fitted)

W x D(mm)	Code	£
915 x 459	84ES94	29.00
1220 x 459	84ES24	35.00
1830 x 459	84ES84	49.00

If ordered separately from a cabinet please add £15.00 carriage



84MD824



84MD894



84MD084

50 Kg shelf capacity (UDL)
THIS MODEL ONLY



84MD024



VIEWCAB VISIBLE STORAGE CABINETS: 88 SERIES

A range of sheet steel cabinets suitable for most working environments e.g. offices, museums, laboratories, schools, factories etc. Available with reinforced doors with maximum area viewing panels in laminated safety glass or polycarbonate. Cabinets available with either steel adjustable shelves (capacity 75 kg per shelf UDL) or toughened glass shelves (capacity 50 kg per shelf UDL). Full choice of colours available.

SEEN, SAFE & SECURE

A range of sheet steel cabinets suitable for your working environment.

88V793



88V894



88S894



88V994



88V944



CABINETS

H x W x D(mm)	Code	£
1830 x 1220 x 460 3 steel shelves	88V824	715.00
1830 x 915 x 460 3 steel shelves	88V894	589.00
915 x 915 x 460 2 steel shelves	88V994	465.00
915 x 460 x 460 2 steel shelves	88V944	376.00

WALL CABINET

H x W x D(mm)	Code	£
712 x 915 x 300 2 steel shelves	88V793	423.00

SPLIT VIEWCAB

H x W x D(mm)	Code	£
1830 x 915 x 460 Top half with glass doors & 2 glass shelves, base has steel doors with 2 steel shelves	88S894	677.00

STEEL EXTRA SHELVES

W x D(mm)	Code	£
460 x 460	88ES44V	17.00
915 x 460	88ES94V	23.00
1220 x 460	88ES24V	27.00

If ordered separately from a cabinet please add £20.00 carriage

GLASS EXTRA SHELVES

W x D(mm)	Code	£
460 x 460	88ES44G	45.00
915 x 460	88ES94G	55.00
1220 x 460	88ES24G	65.00

If ordered separately from a cabinet please add £20.00 carriage

FEATURES & OPTIONS

Full area viewing panel available in 6mm laminated safety glass (BS6206) or tough polycarbonate doors to view your display without compromising security.

Two way locking handle with semi concealed internal mechanism.



SLIDING DOOR CABINETS - 84 SERIES

The perfect storage solution when space is a valuable commodity and should be utilised to its maximum, keeping aisles clear. Ideal for commercial or industrial applications. Welded construction from 0.9mm thick steel. Reinforced doors with 75Kg capacity (UDL) adjustable shelves. Mid Grey RAL 7001 carcass with Blue RAL 5015 doors as standard.

SLIDING DOOR CABINETS

H x W x D(mm)	Code	Shelves	£
1830 x 915 x 460	84894	3	425.68
1830 x 1220 x 460	84824	3	467.74
1020 x 1220 x 460	84024	2	385.98
1020 x 1830 x 460	84084	2	502.82

EXTRA SHELVES (factory fitted)

W x D(mm)	Code	£
915 x 459	84ES94	29.00
1220 x 459	84ES24	35.00
1830 x 459	84ES84	49.00

If ordered separately from a cabinet please add £15.00 carriage

84824



84894



84084

50 Kg shelf capacity (UDL)
THIS MODEL ONLY

84024

- WELDED CONSTRUCTION
- SPACE SAVING
- INDUSTRIAL & COMMERCIAL APPLICATION



If not standard, please specify colour choice at time of order



HEAVY DUTY CABINETS: 80 SERIES

Heavy duty welded construction from 1.2mm thick steel sheet with reinforced double doors mounted on full length hinges secured by 3 way locking flush fitting non snag handle. All cabinets have adjustable shelves (100 kg UDL). 900 & 1200mm high cabinets have 2 shelves, 1500 and 1800mm have 3 shelves. Cabinets Mid Grey RAL 7001 with Blue RAL 5015 doors as standard.

CABINETS - 80 SERIES

H x W x D(mm)	Code	£
900 x 900 x 450	80994	311.88
900 x 900 x 600	80996	347.96
900 x 1200 x 450	80924	370.10
900 x 1200 x 600	80926	413.83
1200 x 900 x 450	80294	360.67
1200 x 900 x 600	80296	400.57
1200 x 1200 x 450	80224	429.49
1200 x 1200 x 600	80226	477.05
1500 x 900 x 450	80594	413.76
1500 x 900 x 600	80596	458.85
1500 x 1200 x 450	80524	494.54
1500 x 1200 x 600	80526	547.52
1800 x 900 x 450	80894	439.95
1800 x 900 x 600	80896	511.47
1800 x 900 x 900	80899	511.47
1800 x 1200 x 450	80824	553.92
1800 x 1200 x 600	80826	610.94
1800 x 1200 x 900	80829	724.98

MOBILE CABINETS - 81 SERIES

H x W x D(mm)	Code	£
900 x 900 x 450	81994	446.58
900 x 900 x 600	81996	506.15
900 x 1200 x 450	81924	528.31
900 x 1200 x 600	81926	555.46
1200 x 900 x 600	81296	558.78
1200 x 1200 x 600	81226	641.58
1500 x 900 x 600	81596	617.85
1500 x 1200 x 600	81526	718.59

EXTRA SHELVES

W x D(mm)	Code	£
900 x 450	80S94	25.55
900 x 600	80S96	27.17
1200 x 450	80S24	33.64
1200 x 600	80S26	39.57

N.B. Cabinet heights do not include castors.
For overall height including castors please add approx. 180mm.

- STRONG 3 WAY LOCKING
- FLUSH NON SNAG HANDLE
- FULL LENGTH SEMICONCEALED HINGES
- 100 KG CAPACITY SHELVES

80994



80894



HEAVY DUTY MOBILE CABINETS - 81 SERIES

These cabinets offer a versatile heavy duty storage solution. Fully welded construction from 1.2mm thick steel sheet fitted with reinforced double doors mounted on heavy duty continuous hinges. Secured by flush fitting non snag 3 way locking handle. Cabinet assemblies are mounted on 2 fixed and 2 swivel braked castors. All cabinets have bolt in adjustable shelves(100 kg UDL). 900 and 1200mm high cabinets have 2 shelves, 1500mm have 3 shelves. Complete with end pull handle.



81596



81994

81296



MORSTOR & HEAVY DUTY SECURITY CABINETS: 82 SERIES

To help meet insurance company requirements, items of value must be locked away in a security cabinet.

MORSTOR - 82 SERIES

H x W x D(mm)	Code	Shelves	£
2000 x 1000 x 600	82215MS	3	824.46

CABINETS - METRIC RANGE

H x W x D(mm)	Code	Shelves	£
1000 x 500 x 500	82155	1	399.55
800 x 1000 x 500	82815	1	601.50
1200 x 1000 x 500	82115	2	834.04
2000 x 1000 x 500	82215	3	899.99

EXTRA SHELVES

W x D(mm)	Code	Shelves	£
500 x 500	82S5	1	35.27
1000 x 500	82S10	1	38.09

If ordered separately from cabinet please add £15.00 carriage

SMALL WALL MOUNTED

H x W x D(mm)	Code	Shelves	£
450 x 380 x 250	82432	1	188.25
1100 x 700 x 250	82172	2	326.09
800 x 800 x 260	82882	2	373.51

EXTRA SHELVES

W x D(mm)	Code	Shelves	£
380 x 250	82S32	1	17.07
700 x 250	82S72	1	18.97
800 x 260	82S82	1	22.77

If ordered separately from cabinet please add £15.00 carriage

COLOUR OPTIONS

A large range of colours is available to compliment your environment.



PLASTIC BINS (Per Pack)

Code	L	W	D(mm)	£	QTY
BB2	165	100	75	46.69	20
BB3	240	150	125	50.37	10
BB4	355	220	125	65.21	10
BB5	355	200	175	78.54	10

Price per pack + £20.00 carriage

MORSTOR CABINET - 82 SERIES

A high density storage cabinet. Welded construction from 1.5mm (carcase) and 2mm (doors) thick steel with double storage doors secured by flush fitting handle. Doors mounted on heavy duty pin hinges and designed to provide extra storage in various configurations with bolt in integral door shelving and 3 adjustable shelves. Blue RAL 5015 as standard.

82215MS
£732.86.



SMALL WALL MOUNTED CABINETS - 82 SERIES

Of welded construction from 2mm thick steel secured by 5 lever mortise lock(s).



882



82432

METRIC SECURITY CABINETS - 82 SERIES

Fully welded construction from 1.5mm (carcase) and 2mm (doors) thick steel. Reinforced double doors mounted on fully recessed hinges, secured by 3 way chrome lever locking handle and 2 five lever mortise locks. Additional security is provided by 2 tower bolts. 100kg capacity shelves. Cabinets Mid Grey RAL 7001 with doors Blue RAL 5015.



82815



82115



82215



HEAVY DUTY ROLLER SHUTTER CABINETS: 90 SERIES

Every workplace has to have a secure storage facility for high value items. The Heavy Duty Roller Shutter Cabinet is the answer. Colour Mid Grey RAL 7001 as standard.



- 100 KG CAPACITY SHELVES
- 150MM HIGH 50KG CAPACITY DRAWERS

CURRENT USES INCLUDE:

- TOOL STORAGE
- HIGH VALUE RETAIL STORAGE
- COMPUTER STORAGE
- EDUCATIONAL APPLICATIONS

CABINETS - 90 SERIES

H x W x D(mm)	Code	£
2000 x 1000 x 500 3 adjustable shelves	90215A	955.84
2000 x 1000 x 500 2 drawers, & 1/2 louvred, 1 shelf*	90215C	1,226.61
2000 x 1000 x 500 6 drawers, & 1/2 louvred, 1 shelf*	90215D	1,567.50
2000 x 1000 x 500 Full louvre	90215E	1,072.21
2000 x 1200 x 500 3 adjustable shelves	90225A	1,053.39
2000 x 1200 x 500 2 drawers, & 1/2 louvred, 1 shelf*	90225C	1,346.31
2000 x 1200 x 500 6 drawers, & 1/2 louvred, 1 shelf*	90225D	1,784.27
2000 x 1200 x 500 Full louvre	90225E	1,125.21

OPTIONAL EXTRAS

Description	Code	£
Extra shelf*	90S15	36.45
Extra shelf*	90S25	51.03

*If ordered separately from a cabinet please add £15.00 carriage



Heavy Duty Pin Locks

90215C



90215D

90215E



90215A



METRIC STORAGE LOCKERS

These coloured lockers are manufactured to the highest specification. Lockers are welded and riveted in construction. Semi concealed hinges are welded to the door and riveted to the frame, allowing easy replacement of doors. Doors positioned within a rebated frame to enhance compartment security. The carcass incorporates nesting holes on all sides and a return flange at the base for extra strength and to reduce floor damage. Lockers are manufactured using cold rolled steel. Material thickness specification 0.9mm doors and frame, 0.7mm carcass and shelves. Components are polyester powder coated prior to assembly to ensure all surfaces are protected. Lockers non returnable unless deemed faulty or damaged.

SINGLE DOOR

H x W x D(mm)	Code	£
1800 x 300 x 300	183030S	77.56
1800 x 300 x 380	183038S	91.10
1800 x 300 x 450	183045S	93.58
1800 x 450 x 450	184545S	112.02

Supplied with a top shelf and double coat hook

TWO DOOR

H x W x D(mm)	Code	£
1800 x 300 x 300	1830302	98.49
1800 x 300 x 380	1830382	104.65
1800 x 300 x 450	1830452	108.35
1800 x 450 x 450	1845452	126.82

Supplied with a top shelf and double coat hook

THREE DOOR

H x W x D(mm)	Code	£
1800 x 300 x 300	1830303	107.11
1800 x 300 x 380	1830383	118.02
1800 x 300 x 450	1830453	121.88

Supplied with no internal fittings

FOUR DOOR

H x W x D(mm)	Code	£
1800 x 300 x 300	1830304	118.20
1800 x 300 x 380	1830384	128.04
1800 x 300 x 450	1830454	131.73
1800 x 450 x 450	1845454	152.66

Supplied with no internal fittings

SIX DOOR

H x W x D(mm)	Code	£
1800 x 300 x 300	1830306	144.05
1800 x 300 x 380	1830386	148.98
1800 x 300 x 450	1830456	153.90

Supplied with no internal fittings

EIGHT DOOR

H x W x D(mm)	Code	£
1800 x 300 x 300	1830308	184.68
1800 x 300 x 450	1830458	203.15

Supplied with no internal fittings

Minimum order value on lockers
£150.00 nett or carriage is payable

- ANTI-BACTERIAL POWDER COATING
- ROBUST CONSTRUCTION
- WELDED FRAME DESIGN
- METRIC SIZED LOCKERS
- LOCK OPTIONS
- SLOPING TOP OPTION



183030S



1830302



1830303

7 COLOUR
OPTIONS
AVAILABLE



1830304



1830306

ALL LOCKERS
SUPPLIED
WITH GREY
CARCASS



1830208

PROBE STORAGE LOCKERS

Each locker is of welded and riveted construction from 0.7mm and 0.9mm sheet steel. Each compartment features an integral air vent system, a micro sprung disc lock, 5 knuckle hinges, welded front frame and internal door strengtheners (not available on all lockers due to manufacturing constraints). Single compartment includes top shelf and double coat hook. Two compartment and double coat hook.



701212



701212/2



701212/3



701212/4



701212/5



701212/6

SINGLE DOOR

H x W x D(mm)	Code	£
1780 x 305 x 305	701212	79.30
1780 x 305 x 380	701215	85.11
1780 x 305 x 460	701218	94.79
1780 x 380 x 380	701515	94.79
1780 x 460 x 460	701818	112.53

TWO DOOR

H x W x D(mm)	Code	£
1780 x 305 x 305	701212/2	103.74
1780 x 305 x 380	701215/2	107.84
1780 x 305 x 460	701218/2	115.75
1780 x 380 x 380	701515/2	115.75
1780 x 460 x 460	701818/2	136.16

THREE DOOR

H x W x D(mm)	Code	£
1780 x 305 x 305	701212/3	112.54
1780 x 305 x 380	701215/3	118.51
1780 x 305 x 460	701218/3	126.17
1780 x 460 x 460	701818/3	144.68

FOUR DOOR

H x W x D(mm)	Code	£
1780 x 305 x 305	701212/4	120.33
1780 x 305 x 380	701215/4	129.66
1780 x 305 x 460	701218/4	135.18
1780 x 380 x 380	701515/4	135.18
1780 x 460 x 460	701818/4	157.32

FIVE DOOR

H x W x D(mm)	Code	£
1780 x 305 x 305	701212/5	148.37
1780 x 305 x 380	701215/5	133.94
1780 x 305 x 460	701218/5	141.37

SIX DOOR

H x W x D(mm)	Code	£
1780 x 305 x 305	701212/6	148.37
1780 x 305 x 380	701215/6	150.59
1780 x 305 x 460	701218/6	161.60
1780 x 380 x 380	701818/6	161.60

PROBE LOCKERS

Carcase
Smoke White
Silver
Black
Yellow
Blue
Red

COLOUR OPTIONS

Door
Smoke White
Silver
Green

- FRESH DESIGN - SUITS MOST ENVIRONMENT
- AIR VENT SYSTEM - ALLOWS EACH COMPARTMENT TO BREATHE
- QUALITY 10 DISC SECURE LOCK SYSTEM
- WELDED PLINTH BETWEEN EACH COMPARTMENT



MESH LOCKERS

Wire Mesh lockers are ideal for most applications and offer excellent ventilation and high visual security. Manufactured from 25mm x 25mm x 2.5mm weld mesh on an 8mm rod frame. 1980mm high x 305mm wide x 305mm or 450mm deep. All lockers are fitted with 150mm legs as standard enabling easy access for cleaning. Single and two compartment lockers are fitted with coat hooks and have 3 point locking. Doors are fitted with hasp & staple for use with padlocks (sold separately)

FULL HEIGHT

SINGLE DOOR

H x W x D(mm)	Code	£
1980 x 305 x 305	19303011	150.95
1980 x 305 x 457	19304511	152.43

TWO DOOR

H x W x D(mm)	Code	£
1980 x 305 x 305	19303021	156.76
1980 x 305 x 457	19304521	171.79

FOUR DOOR

H x W x D(mm)	Code	£
1980 x 305 x 305	19303041	174.06
1980 x 305 x 457	19304541	189.69

SIX DOOR

H x W x D(mm)	Code	£
1980 x 305 x 305	19303061	197.57
1980 x 305 x 457	19304561	214.85

MIDI HEIGHT (SINGLE DOOR)

H x W x D(mm)	Code	£
1370 x 305 x 305	13703011	132.26
1370 x 305 x 457	13704511	140.76

MIDI HEIGHT (TWO DOOR)

H x W x D(mm)	Code	£
1370 x 305 x 305	13703021	136.27
1370 x 305 x 457	13704521	147.82

MIDI HEIGHT (FOUR DOOR)

H x W x D(mm)	Code	£
1370 x 305 x 305	13703041	141.61
1370 x 305 x 457	13704541	155.20

FULL HEIGHT

All mesh lockers available in:
Electro galvanised as standard.
Blue, Dark Green, Light Green, Red,
Yellow, Light Grey, Dark Grey



MULTI COMPARTMENT

12 COMPARTMENTS (with doors)

H x W x D(mm)	Code	£
1370 x 910 x 305	13703012D	420.70
1370 x 910 x 457	13704512D	485.92

12 COMPARTMENTS (without doors)

H x W x D(mm)	Code	£
1370 x 910 x 305	13703012	246.62
1370 x 910 x 457	13704512	291.61

20 COMPARTMENTS (with doors)

H x W x D(mm)	Code	£
1370 x 1520 x 305	13703020D	649.92
1370 x 1520 x 457	13704520D	716.68

20 COMPARTMENTS (without doors)

H x W x D(mm)	Code	£
1370 x 1520 x 305	13703020	361.24
1370 x 1520 x 457	13704520	445.78

40 COMPARTMENTS (with doors)

H x W x D(mm)	Code	£
1370 x 830 x 305	13704040D	432.34
1370 x 830 x 457	13704540D	426.53

40 COMPARTMENTS (without doors)

H x W x D(mm)	Code	£
1370 x 830 x 305	13704040	345.27
1370 x 830 x 457	13704540	380.74

WIRE MESH LOCKERS - MULTI COMPARTMENT

Offering a solution to multiple storage of smaller personal items. 12 or 16 compartment available with or without doors. 40 compartment available with or without double doors.



12 compartment - no doors



20 compartment - no doors



40 compartment with double doors



HEAVY DUTY TOUGH CUBES: 18 SERIES

Welded construction from 1.2mm thick steel. Each cube is fitted with a shelf and can be sited side-by-side or back-to-back to form a partition. Card holder, hasp & staple, perforated doors also available. Mid grey RAL 7001 carcass with blue RAL 5015 doors as standard.

TOUGH CUBES - 18 SERIES



ONE COMPARTMENT

H x W x D(mm)	Code	£
665 x 600 x 600	18666	159.31

TWO COMPARTMENT

H x W x D(mm)	Code	£
1220 x 600 x 600	18266	308.71

THREE COMPARTMENT

H x W x D(mm)	Code	£
1780 x 600 x 600	18766	451.11



If not standard, please specify colour choice at time of order

PLASTIC LOCKERS

Great appearance with blue, red yellow and green coloured doors. Hardwearing and washable. Ideally suited for education.

- VANDAL RESISTANT TOUGH POLYTHENE
 - EASILY STACKED & NESTED
 - LABEL POSITION & AIR VENTS ON ALL DOOR SIZES
- SUITABLE FOR:
- WET CHANGING ROOMS
 - OUTDOOR USE
 - WASH DOWN AREAS



PLASTIC LOCKERS

H x W x D(mm)	Code	£
450 x 320 x 460 Grey / Blue	BIEPL434GB	125.00
450 x 320 x 460 Grey / Red	BIEPL434GR	125.00
450 x 320 x 460 Grey / Yellow	BIEPL434GY	125.00
450 x 320 x 460 Grey / Green	BIEPL434GG	125.00

H x W x D(mm)	Code	£
600 x 320 x 460 Grey / Blue	BIEPL634GB	141.00
600 x 320 x 460 Grey / Red	BIEPL634GR	141.00
600 x 320 x 460 Grey / Yellow	BIEPL634GY	141.00
600 x 320 x 460 Grey / Green	BIEPL634GG	141.00

H x W x D(mm)	Code	£
900 x 320 x 460 Grey / Blue	BIEPL934GB	166.00
900 x 320 x 460 Grey / Red	BIEPL934GR	166.00
900 x 320 x 460 Grey / Yellow	BIEPL934GY	166.00
900 x 320 x 460 Grey / Green	BIEPL934GG	166.00



STAINLESS STEEL EQUIPMENT

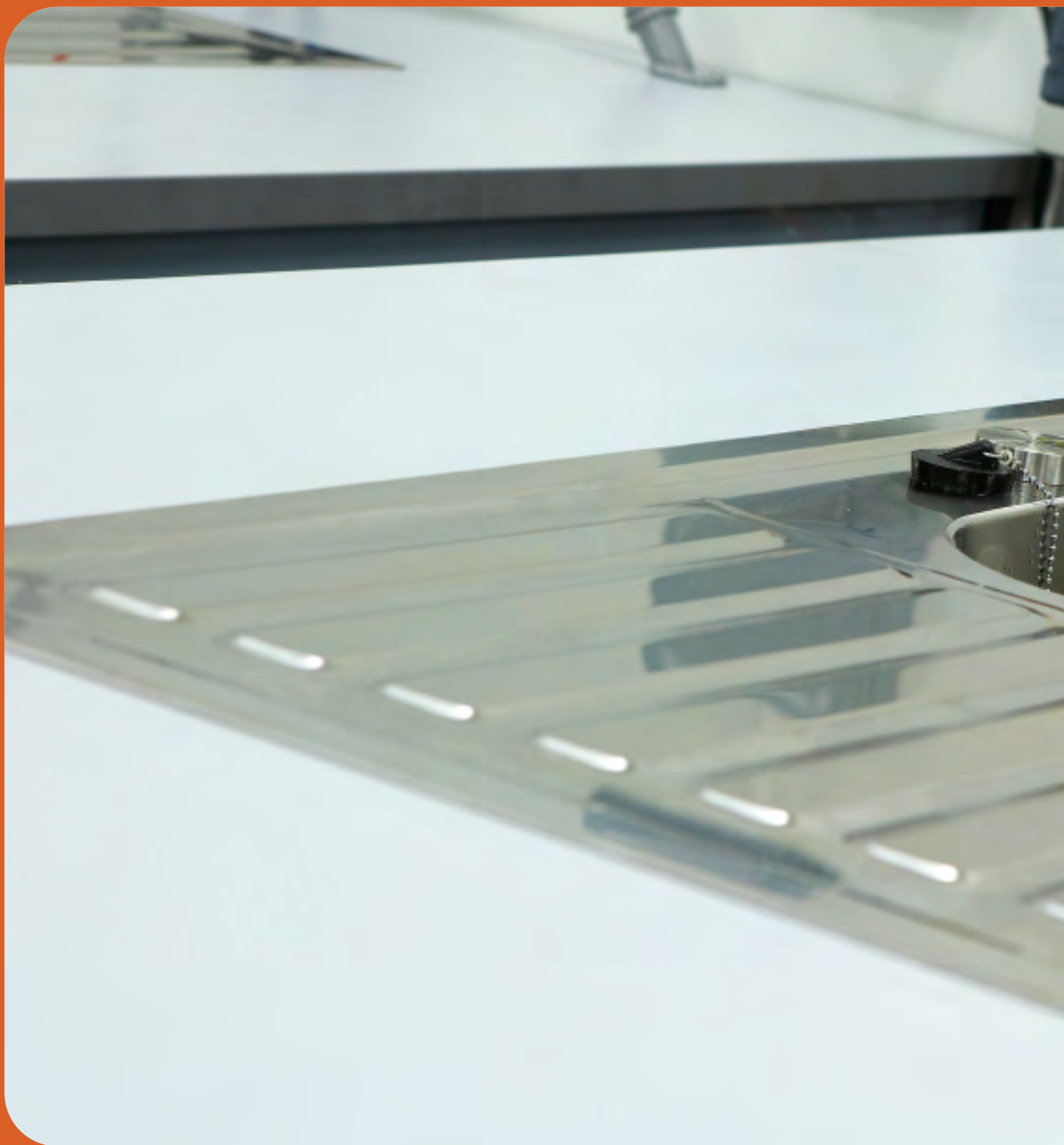



HEAVY DUTY STAINLESS STEEL WORKBENCHES & TROLLEYS

BENCHES

L x W x H(mm)	Code	£
800 x 750 x 840	478075	444.92
1200 x 750 x 840	471275	502.95
1500 x 750 x 840	471575	559.38
1800 x 750 x 840	471875	623.88
2400 x 750 x 840	472475†	799.95

†This model has additional leg supports

600 and 900 wide options are also available, POA

CABINETS (factory fitted)

Description	Code	£
Cabinet Unit	SC1	283.71
800mm Full Cabinet	SC08	627.85
1200mm Full Cabinet	SC12	765.73
1500mm Full Cabinet	SC15	916.20
1800mm Full Cabinet	SC18	1,051.11
2400mm Full Cabinet	SC24	1,314.99

DRAWERS (factory fitted)

Description	Code	£
Single Drawer Unit	SD1	199.95
Double Drawer Unit	SD2	399.95
Triple drawer Unit	SD3	599.95

ACCESSORIES (factory fitted)

Description	Code	£
800mm Base Shelf	SBS8	102.17
1200mm Base Shelf	SBS12	143.37
1500mm Base Shelf	SBS15	166.43
1800mm Base Shelf	SBS18	185.55
2400mm Base Shelf	SBS24	268.60

Perforated Back Panel	SLP	246.65
Electrical Service Duct	SSD	228.91
Upper Shelf	SUS	177.33
Overhead Light Unit	SLU	195.18
Rear Upright Supports	SAP	162.83

TROLLEYS (SMT)

L900 x W420 x H840(mm) + Castors

Description	Code	£
2 Tier	SMT1	535.19
3 Tier	SMT2	635.14
2 Tier c/w Cabinet	SMT3	818.88

L1000 x W420 x H840(mm) + Castors

2 Tier c/w Cabinet & Drawer	SMT4	970.24
-----------------------------	------	--------

TROLLEYS (SMTL)

L1200 x W550 x H840(mm) + Castors

Description	Code	£
2 Tier	SMTL1	578.72
3 Tier	SMTL2	702.98
2 Tier c/w Cabinet	SMTL3	862.43
2 Tier c/w Cabinet & Drawer	SMTL4	999.95

OPTIONS

Description	Code	£
Braked Castors (pair)	BC	30.00

WORKBENCHES - 47 SERIES

Heavy duty all stainless steel workbench units, of welded construction with 2mm thick 304 quality reinforced worktop with a brushed polish finish, mounted on 40mm square stainless steel tubular leg supports with plastic adjustable feet.



HEAVY DUTY STAINLESS STEEL TROLLEYS - SMT SERIES

A range of heavy duty welded trolleys constructed throughout in 304 quality stainless steel with a brushed polish finish. The units have a 2mm thick worktop mounted on 40mm square framework complete with 100mm diameter stainless steel castors with grey non-marking tyres. Total trolley capacity of 150kg.



304 QUALITY STAINLESS STEEL

A range of heavy duty welded trolleys constructed in 304 quality stainless steel with 2mm thick top mounted on 40mm square framework. Shown with optional braked castors

STAINLESS STEEL CABINETS & DESK UNITS: 87 SERIES

Welded and riveted construction from 304 quality stainless steel sheet with a brushed polish finish. Manufactured with reinforced doors mounted on pin hinges secured by flush mounted three way locking handle. The cabinets fitted internally with adjustable shelves (capacity 75 kg per shelf UDL).



CABINETS

H x W x D(mm)	Code	Shelves	£
600 x 450 x 300	87643	1	285.33
600 x 450 x 450	87644	1	299.83
900 x 450 x 450	87944	2	396.55
900 x 450 x 450	87944D	1 + Drawer	549.77
1800 x 450 x 450	87844R	1 + Rail	625.47
900 x 880 x 450	87984	2	633.87
1200 x 880 x 450	87284	2	735.09
1500 x 880 x 450	87584	3	883.40
1800 x 880 x 450	87884	3	899.95

EXTRA SHELVES

W x D(mm)	Code	£
450 x 450	874S	39.95
880 x 450	879S	59.95

If ordered separately from a cabinet please add £15.00 carriage

DESK UNITS

H x W x D(mm)	Code	Shelves	£
1175 x 880 x 450	87SDC	2 + Drawer	899.95
Sloping Top On Base Cabinet			
1175 x 880 x 450	87SDL	1 + Drawer	599.95
Sloping Top On 4 Legs			

OPTIONS & ACCESSORIES (factory fitted)

Description	Code	£
Stainless Steel Castor Set	SC90	179.95
Zinc Plated Castor Set	ZC80	79.95
Sloping Top 450mm Wide	ST44	89.99
Sloping Top 880mm Wide	ST84	159.95
Leg Units	LU100	129.95

Choice of louvre panels also available

- BRUSHED POLISH FINISH
- WELDED AND RIVETED CONSTRUCTION
- 'NON SNAG' 3 WAY LOCKING HANDLE

304 QUALITY STAINLESS STEEL

Welded and riveted construction from 304 quality stainless steel sheet with a brushed polish finish.



STAINLESS STEEL LOCKERS: SL SERIES

Welded and riveted construction from 304 quality stainless steel sheet with a brushed polish finish. Doors fitted with semi concealed hinges, secured by camlock with two keys. The single compartment locker is fitted with a hat shelf and two coat hooks. Two compartments each fitted with 2 coat hooks. Supplied individually and pre-drilled ready for nesting into banks if required.

SINGLE DOOR

H x W x D(mm)	Code	£
1778 x 305 x 305	SL33/1	393.16
1778 x 305 x 381	SL38/1	441.44
1778 x 305 x 457	SL34/1	486.85
1778 x 457 x 457	SL44/1	533.68

TWO DOOR

H x W x D(mm)	Code	£
1778 x 305 x 305	SL33/2	478.32
1778 x 305 x 381	SL38/2	512.40
1778 x 305 x 457	SL34/2	547.91
1778 x 457 x 457	SL44/2	599.95

THREE DOOR

H x W x D(mm)	Code	£
1778 x 305 x 305	SL33/3	523.74
1778 x 305 x 381	SL38/3	562.08
1778 x 305 x 457	SL34/3	599.95
1778 x 457 x 457	SL44/3	660.02

FOUR DOOR

H x W x D(mm)	Code	£
1778 x 305 x 305	SL33/4	569.18
1778 x 305 x 381	SL38/4	611.78
1778 x 305 x 457	SL34/4	652.92
1778 x 457 x 457	SL44/4	569.19

SIX DOOR

H x W x D(mm)	Code	£
1778 x 305 x 305	SL33/6	674.20
1778 x 305 x 381	SL38/6	705.44
1778 x 305 x 457	SL34/6	739.50
1778 x 457 x 457	SL44/6	799.95

CUBE LOCKERS

H x W x D(mm)	Code	£
305 x 305 x 305	SLC30	173.80
381 x 381 x 381	SLC35	179.95
457 x 457 x 457	SLC44	185.95
610 x 457 x 457	SLC64	197.26

GARMENT COLLECTOR

H x W x D(mm)	Code	£
1778 x 381 x 457	SL34CL	540.56

GARMENT DISPENSING

H x W x D(mm)	Code	£
1778 x 381 x 457	SL34D10	859.95
1778 x 381 x 457	SL34D15	999.95

CLEAN & DIRTY

H x W x D(mm)	Code	£
1778 x 457 x 457	SL44CD	599.95

TWIN LOCKER

H x W x D(mm)	Code	£
1778 x 457 x 457	SL44TW	599.95

ACCESSORIES (factory fitted)

Description	£
Sloping Tops For All Standard Sizes	89.95
Leg Units For All Single Lockers	79.95
Perforated Doors	49.95



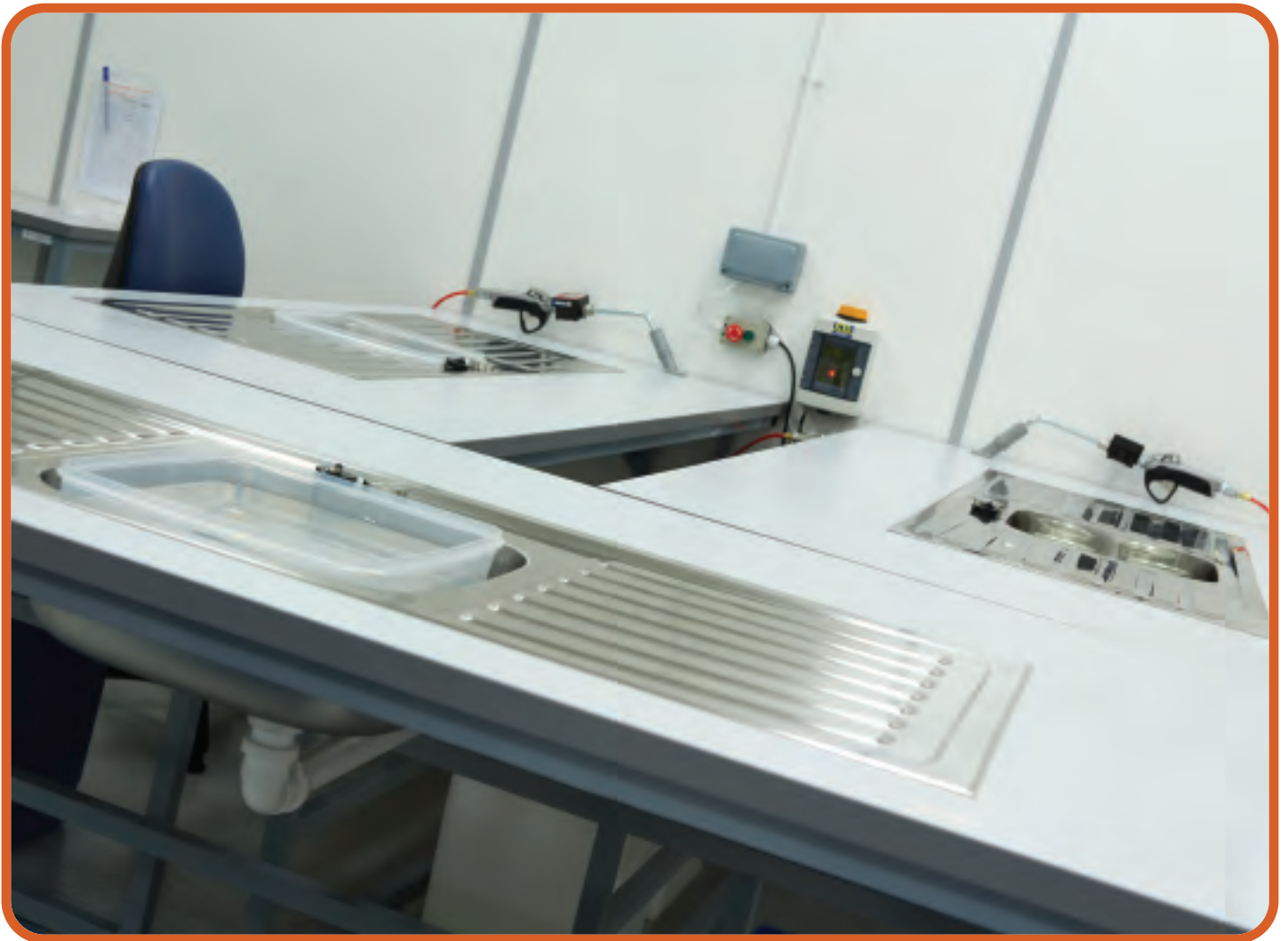

TERMS & CONDITIONS

Prices quoted are exclusive of VAT

Where otherwise stated prices include delivery to the UK Mainland only, excluding Northern Scotland, Highlands and Islands.

Please note our normal delivery service is applied to this priced product guide and does not include a day or time specific option. A special delivery service can be arranged to include this option at extra cost.

Normal deliveries will take place between 8:00am and 5:00pm Monday to Friday.

Other than collection, goods will be delivered to the nearest point of entry, off-loading being your responsibility, e.g. a ground floor reception/goods inward area - not positioning on site.

All goods must be checked for damages and/or shortages before signing the delivery note(s).

Please contact us for authorisation in the unlikely event of returning goods. There is a handling charge of 15% of the invoice value plus delivery charges will apply.

Bespoke items cannot be returned unless deemed defective / faulty.

Lockers non returnable unless deemed faulty or damaged.

Minimum order value on lockers £150.00 or carriage is payable.

We can accept orders on a call off basis if the delivery dates are agreed and quoted on the purchase order. Call off dates may not be changed without prior agreement.

First orders are on a pro-forma basis. Subsequent orders are payable on nett monthly account subject to status.

Retention of Title - Goods remain the property of the manufacturer until paid for in full.

Copies of our full Terms & Conditions Of Sale are available on request. (Priced Product Guide - Version 8.0 01-09-11)

Please note: Prices are correct at time of publication (Sept 2011) however due to fluctuations in raw material cost, prices are for reference only. To confirm the current prices please contact the Sales Team

